

Profili MACAP

MACAP Profiles

SERIES

20

25

30

ACCESSORI
ACCESSORIES

Profili / Profiles

INDICE / INDEX

SERIE 20 / <i>SERIES 20</i>	07
SERIE 25 / <i>SERIES 25</i>	15
SERIE 30 / <i>SERIES 30</i>	29
GUARNIZIONI E ACCESSORI <i>GASKETS AND ACCESSORIES</i>	45

Esempio di costruzione di uno sportello / Example of construction of a hatch

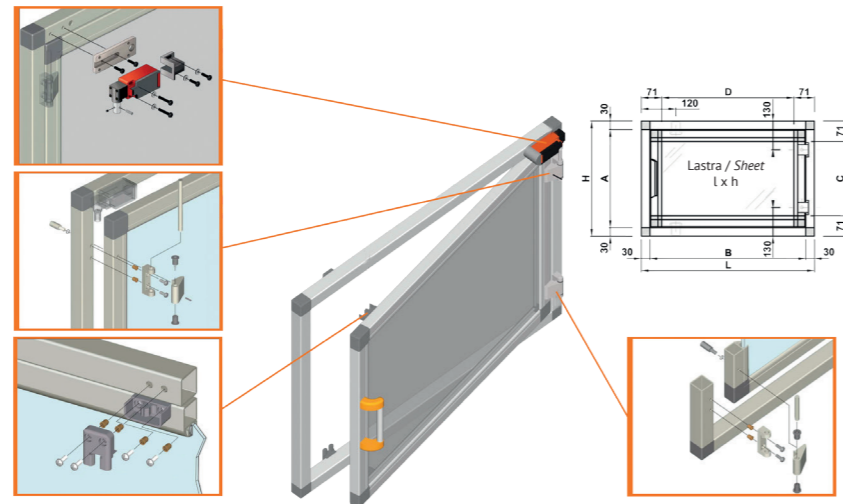

Caratteristiche tecniche / Technical features

Tabella di taglio / Cutting table

Telaio / Frame		Sportello / Hatch		Lastra / Sheet	
A	B	C	D	l	h
H-60	L-60	H-142	L-142	L-121	H-121

N.B. Per il calcolo delle misure, nella tabella di taglio è stata considerata una luce di 3mm tra l'esterno dello sportello e l'interno del telaio.
 N.B. To calculate the measurements, a 3mm gap between the outside of the hatch and the inside of the frame was given in the cutting table.

Esempio di costruzione di un portellone / Example of construction of a hatch

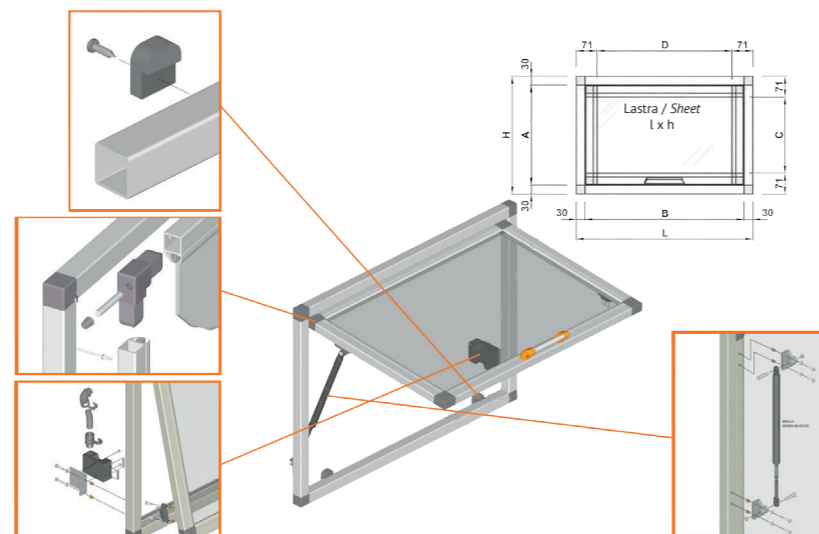

Caratteristiche tecniche / Technical features

Tabella di taglio / Cutting table

Telaio / Frame		Portellone / Hatch		Lastra / Sheet	
A	B	C	D	l	h
H-60	L-60	H-142	L-142	L-121	H-121

N.B. Per il calcolo delle misure, nella tabella di taglio è stata considerata una luce di 3mm tra l'esterno dello sportello e l'interno del telaio.
 N.B. To calculate the measurements, a 3mm gap between the outside of the hatch and the inside of the frame was given in the cutting table.

Esempio di costruzione di uno sportello / Example of construction of a hatch

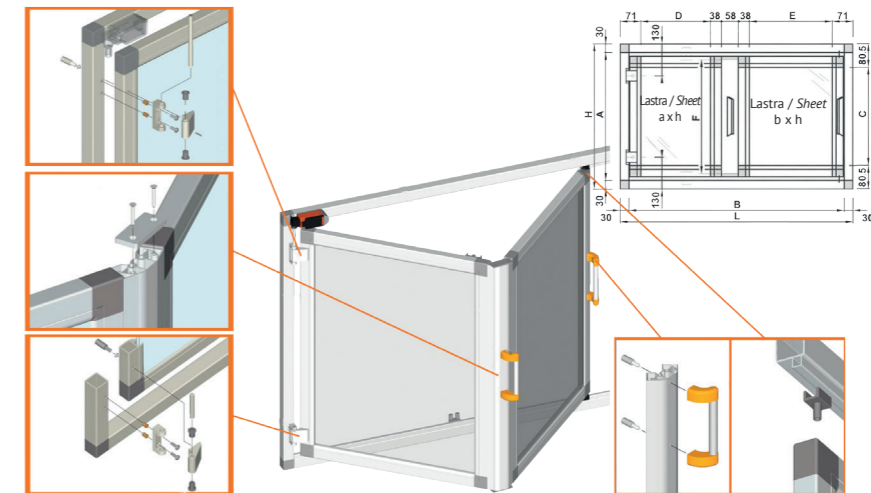

Caratteristiche tecniche / Technical features

Tabella di taglio / Cutting table

Telaio / Frame		Soffietto / Bellows				Lastra / Sheet		
A	B	C	D	E	F	a	b	h
H-60	L-60	H-61	$[(L-276)/2]-23$	$[(L-276)/2]+23$	H-91	$[(L-234)/2]-23$	$[(L-234)/2]+23$	H-140

N.B. Per il calcolo delle misure, nella tabella di taglio è stata considerata una luce di 3mm tra l'esterno dello sportello e l'interno del telaio.
 N.B. To calculate the measurements, a 3mm gap between the outside of the hatch and the inside of the frame was given in the cutting table.

Esempio di costruzione di una porta scorrevole / Example of construction of a sliding door

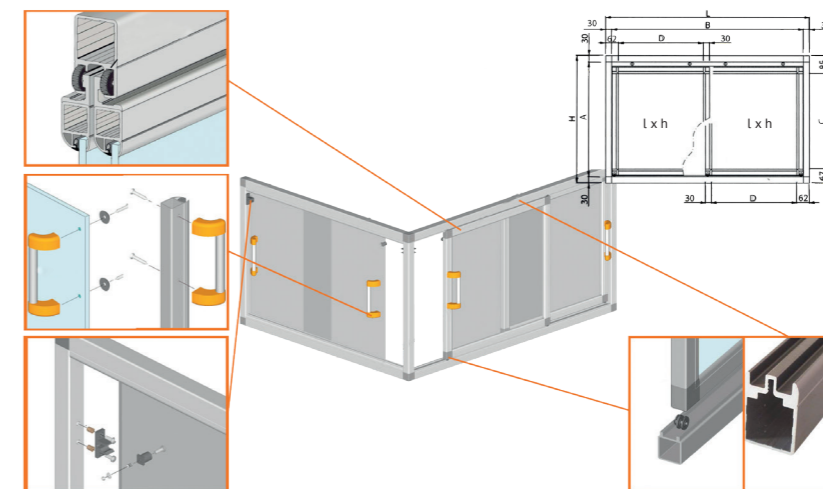

Caratteristiche tecniche / Technical features

Tabella di taglio / Cutting table

Telaio / Frame		Sportello / Hatch		Lastra / Sheet	
A	B	C	D	l	h
H-60	L-60	H-152	$(L/2)-82$	$(L/2)-67$	H-137

N.B. Per il calcolo delle misure, nella tabella di taglio è stata considerata una luce di 3mm tra l'esterno dello sportello e l'interno del telaio.
 N.B. To calculate the measurements, a 3mm gap between the outside of the hatch and the inside of the frame was given in the cutting table.

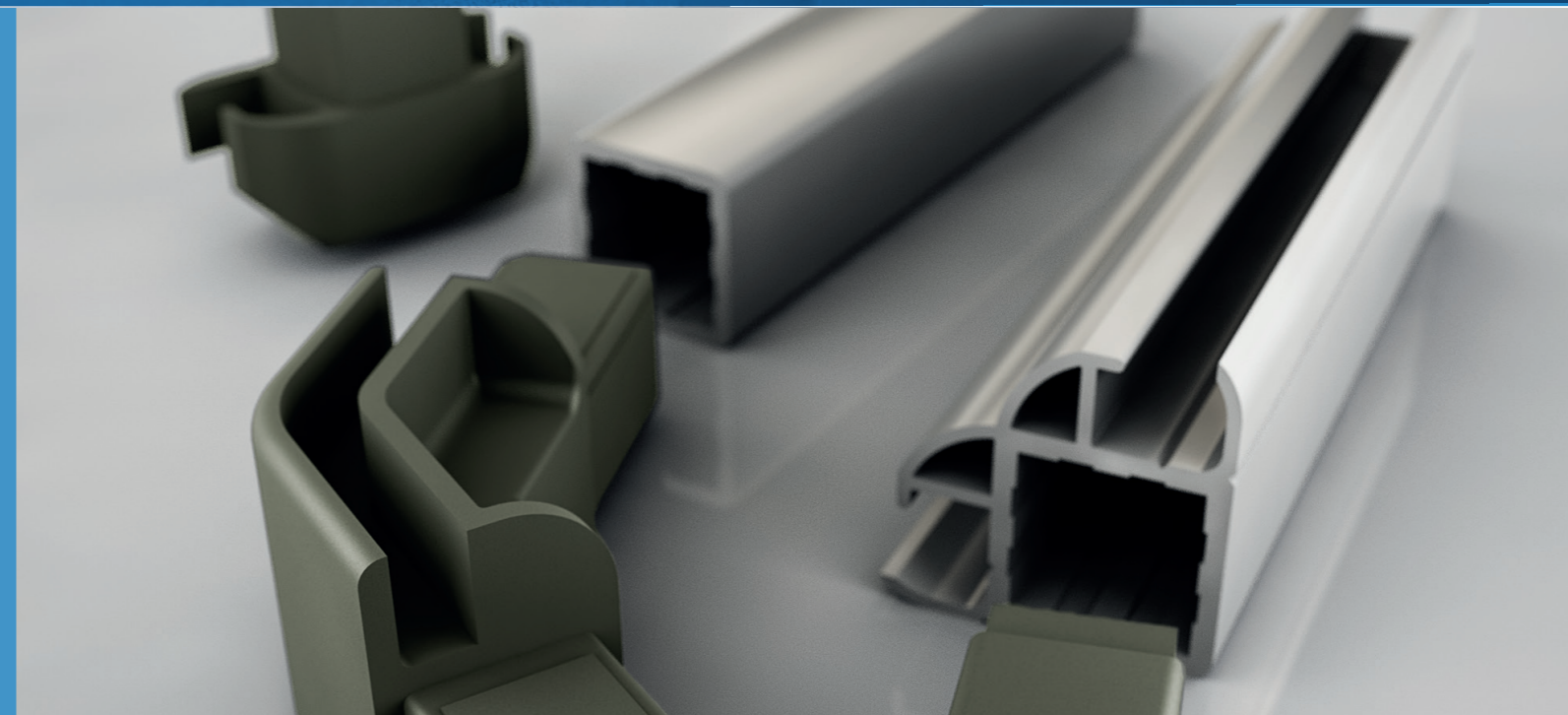

PROFILI SERIE 20 SERIES 20 PROFILES

La linea di prodotti "Dierre-Macap", evoluta grazie all'esperienza maturata nel settore, mette a disposizione un'ampia gamma di soluzioni; i profili e i componenti Serie 20 nascono dall'esigenza di avere un minimo ingombro sulla struttura del pannello ma allo stesso tempo garantire una vasta gamma di scelta di soluzioni di montaggio e un'ottima stabilità della struttura montata.

The "Dierre-Macap" product line, that evolved thanks to the experience gained in the sector, offers a wide range of solutions; Series 20 profiles and components arise from the need to have a minimum footprint on the panel structure but at the same time ensure a wide range of choice of assembly solutions and excellent stability of the assembled structure.

N.B. Tutte le immagini di questo catalogo sono rendering realizzati dai disegni 3D degli articoli raffigurati, pertanto il colore del materiale in queste immagini potrebbe non corrispondere esattamente alla tonalità reale degli articoli.
Per qualsiasi informazione contattare info@dierre.eu

N.B.: All images in this catalogue are renderings made from 3D drawings of the items depicted, therefore the colour of the material in these images may not exactly match the actual shade of the items.
For any information contact info@dierre.eu

Profilato 20-4R / Profile 20-4R

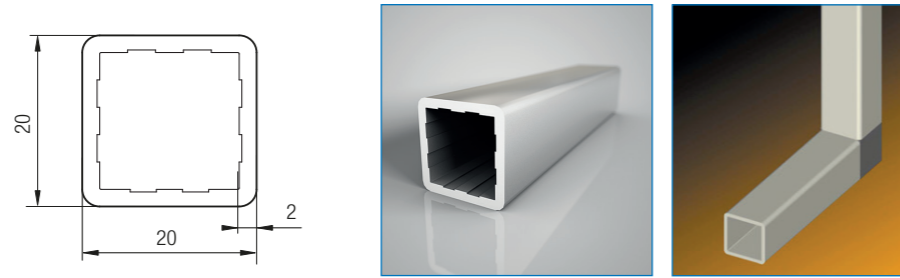

Caratteristiche tecniche / Technical features		
Materiale / Material	Codice / Code	Peso (kg/mt) / Weight (kg/m)
Alluminio anodizzato ELOX / ELOX anodized aluminium	BPRDD0000277 / XB25120E	0,363
Alluminio anodizzato ARGENTO / SILVER anodized aluminium	BPRDD0000276 / XB25120	0,363
Lunghezza barra 6000 mm / Bar length 6000 mm		

Profilato 20-1V tamponato / Buffer profile 20-1V

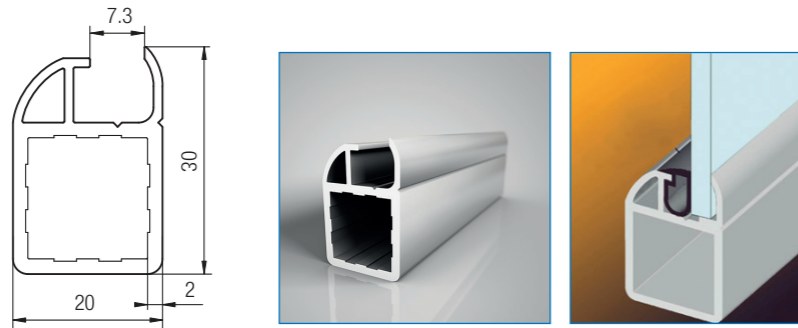

Caratteristiche tecniche / Technical features		
Materiale / Material	Codice / Code	Peso (kg/mt) / Weight (kg/m)
Alluminio anodizzato ELOX / ELOX anodized aluminium	BPRDD0000280 / XB25520E	0,448
Alluminio anodizzato ARGENTO / SILVER anodized aluminium	BPRDD0000279 / XB25520	0,448
Lunghezza barra 6000 mm / Bar length 6000 mm		

Profilato 20-2VL tamponato / Buffer profile 20-2VL

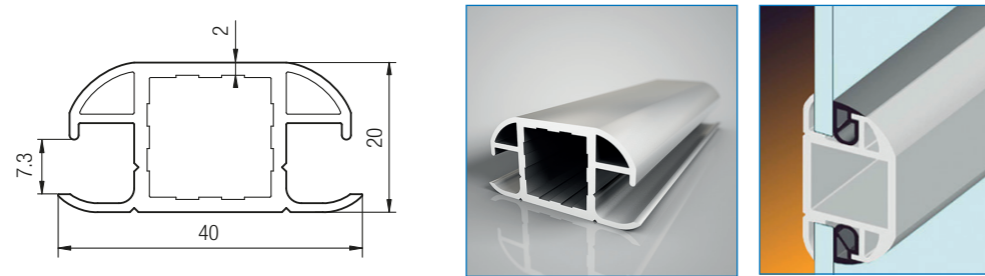

Caratteristiche tecniche / Technical features		
Materiale / Material	Codice / Code	Peso (kg/mt) / Weight (kg/m)
Alluminio anodizzato ELOX / ELOX anodized aluminium	BPRDD0000286 / XB25521E	0,571
Alluminio anodizzato ARGENTO / SILVER anodized aluminium	BPRDD0000285 / XB25521	0,571
Lunghezza barra 6000 mm / Bar length 6000 mm		

Profilato 20-2VA tamponato / Buffer profile 20-2VA

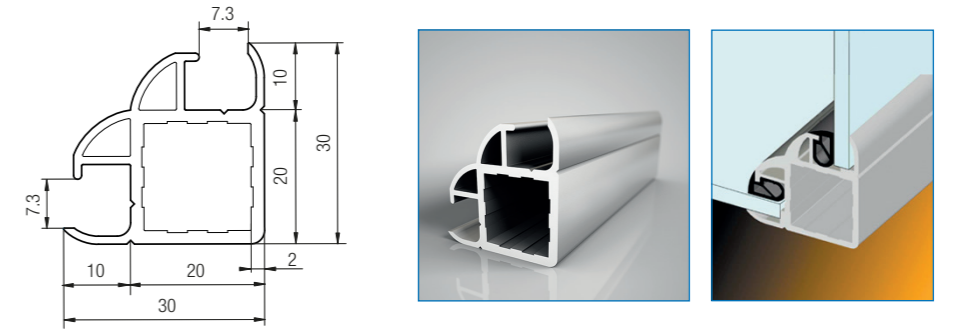

Caratteristiche tecniche / Technical features		
Materiale / Material	Codice / Code	Peso (kg/mt) / Weight (kg/m)
Alluminio anodizzato ELOX / ELOX anodized aluminium	BPRDD0000283 / XB25522E	0,569
Alluminio anodizzato ARGENTO / SILVER anodized aluminium	BPRDD0000282 / XB25522	0,569
Lunghezza barra 6000 mm / Bar length 6000 mm		

Giunzione 20-3VA / Connection 20-3VA

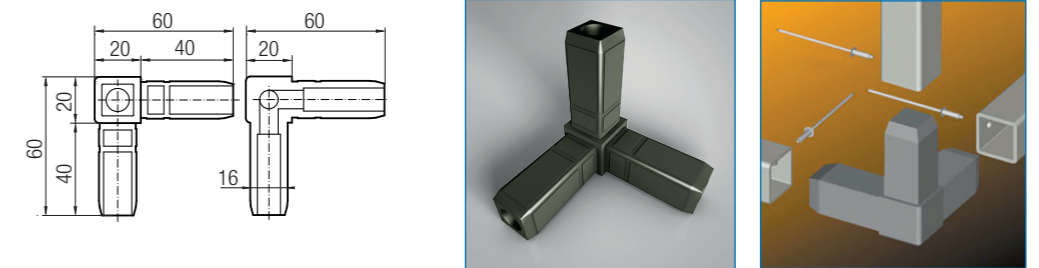

Caratteristiche tecniche / Technical features		
Materiale / Material	Codice / Code	Peso (gr) / Weight (g)
Nylon RAL 7039 / Nylon RAL 7039	DGIPD0000028 / XF30003G	28,00
Confezione da 100 Pz. / Pack of 100 Pcs.		

Giunzione 20-2VA / Connection 20-2VA

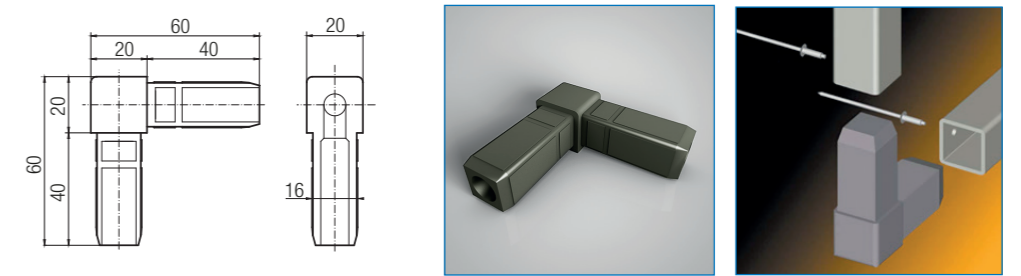

Caratteristiche tecniche / Technical features		
Materiale / Material	Codice / Code	Peso (gr) / Weight (g)
Nylon RAL 7039 / Nylon RAL 7039	DGIPD0000024 / XF30007G	26,00
Confezione da 100 Pz. / Pack of 100 Pcs.		

Giunzione 20-2VA R15 con cornice / 20-2VA R15 Connection with frame

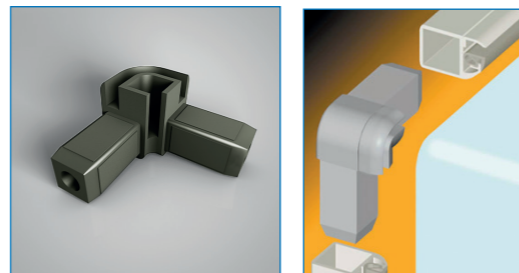
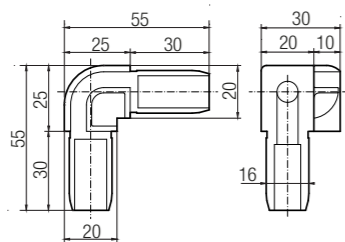

Caratteristiche tecniche / Technical features

Materiale / Material	Codice / Code	Peso (gr) / Weight (g)
Nylon RAL 7039 / Nylon RAL 7039	DGIPD0000026 / XF30005G	26,00
Confezione da 100 Pz. / Pack of 100 Pcs.		

Giunzione 20-1V / Connection 20-1V

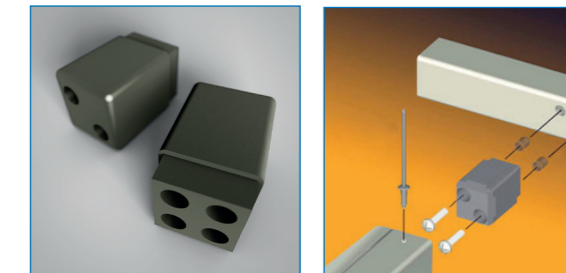
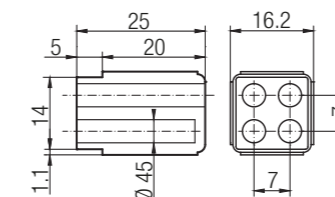

Caratteristiche tecniche / Technical features

Materiale / Material	Codice / Code	Peso (gr) / Weight (g)
Nylon RAL 7039 / Nylon RAL 7039	DGIPD0000022 / XF30001G	6,00
Confezione da 200 Pz. / Pack of 200 Pcs.		

Giunzione 20-2VA 45° con cornice / 20-2VA 45° Connection with frame

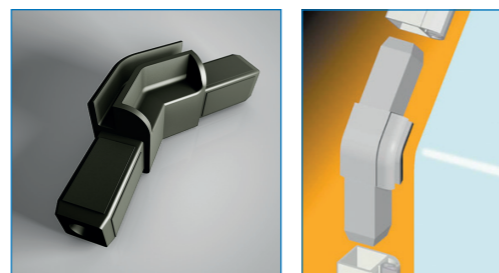
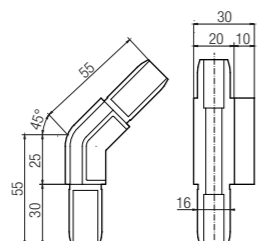

Caratteristiche tecniche / Technical features

Materiale / Material	Codice / Code	Peso (gr) / Weight (g)
Nylon RAL 7039 / Nylon RAL 7039	DGIPD0000025 / XF30006G	33,00
Confezione da 100 Pz. / Pack of 100 Pcs.		

Collarino per giunzione 20-1V / Connection collar 20-1V

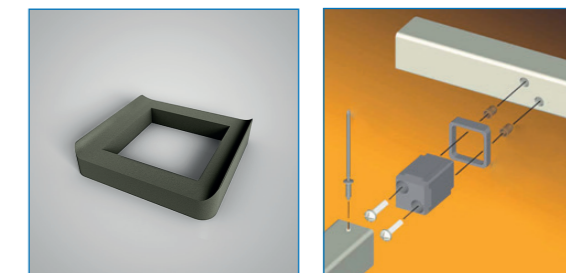
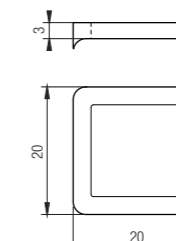

Caratteristiche tecniche / Technical features

Materiale / Material	Codice / Code	Peso (gr) / Weight (g)
Nylon RAL 7039 / Nylon RAL 7039	DBOXX0000043 / XF62001G	1,00
Confezione da 200 Pz. / Pack of 200 Pcs.		

Collarino giunzione 20 / 20 Connection collar

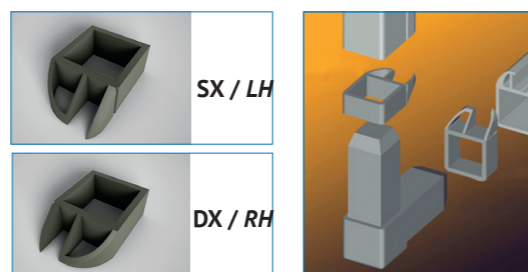
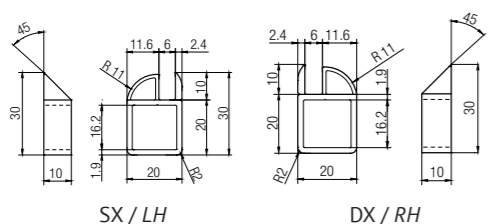

Caratteristiche tecniche / Technical features

Materiale / Material	Codice / Code	Peso (gr) / Weight (g)
Nylon RAL 7039 SX / Nylon RAL 7039 LH	DBOXX0000035 / XF62010G	2,00
Nylon RAL 7039 DX / Nylon RAL 7039 RH	DBOXX0000034 / XF62011G	2,00
Confezione da 200 Pz. / Pack of 200 Pcs.		

Giunzione 20-2VL / Connection 20-2VL

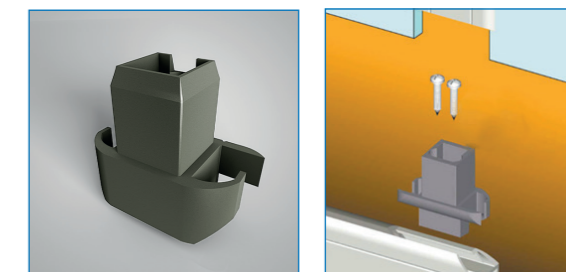
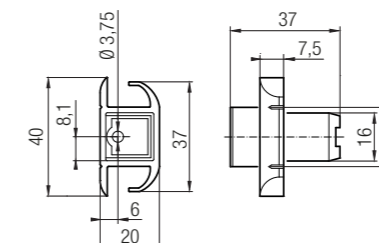

Caratteristiche tecniche / Technical features

Materiale / Material	Codice / Code	Peso (gr) / Weight (g)
Nylon RAL 7039 / Nylon RAL 7039	DGIPD0000027 / XF30004G	9,00
Confezione da 200 Pz. / Pack of 200 Pcs.		

Cornice per giunzione 20-2VA 90° / Frame for 20-2VA 90° connection

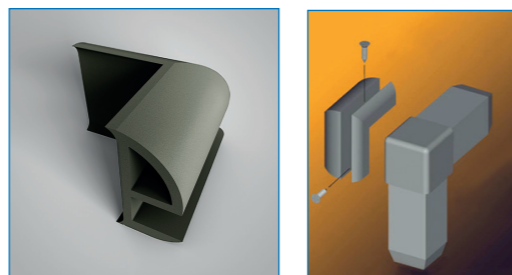
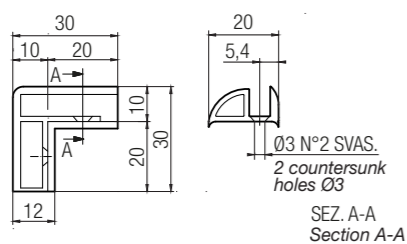

Caratteristiche tecniche / Technical features

Materiale / Material	Codice / Code	Peso (gr) / Weight (g)
Nylon RAL 7039 / Nylon RAL 7039	DGIPD0000002 / XF31110G	26,00
Confezione da 200 Pz. / Pack of 100 Pcs.		

Tappo tubolare 20 / 20 Tube cap

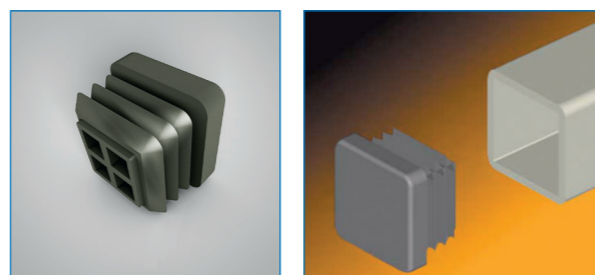
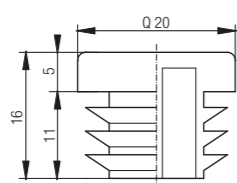

Caratteristiche tecniche / Technical features

Materiale / Material	Codice / Code	Peso (gr) / Weight (g)
Nylon Nero / Black nylon	CTPTU0000008 / XC30120	2,50
Nylon RAL 7039 / Nylon RAL 7039	CTPTU0000009 / XC30120G	2,50
Confezione da 100 Pz. / Pack of 100 Pcs.		

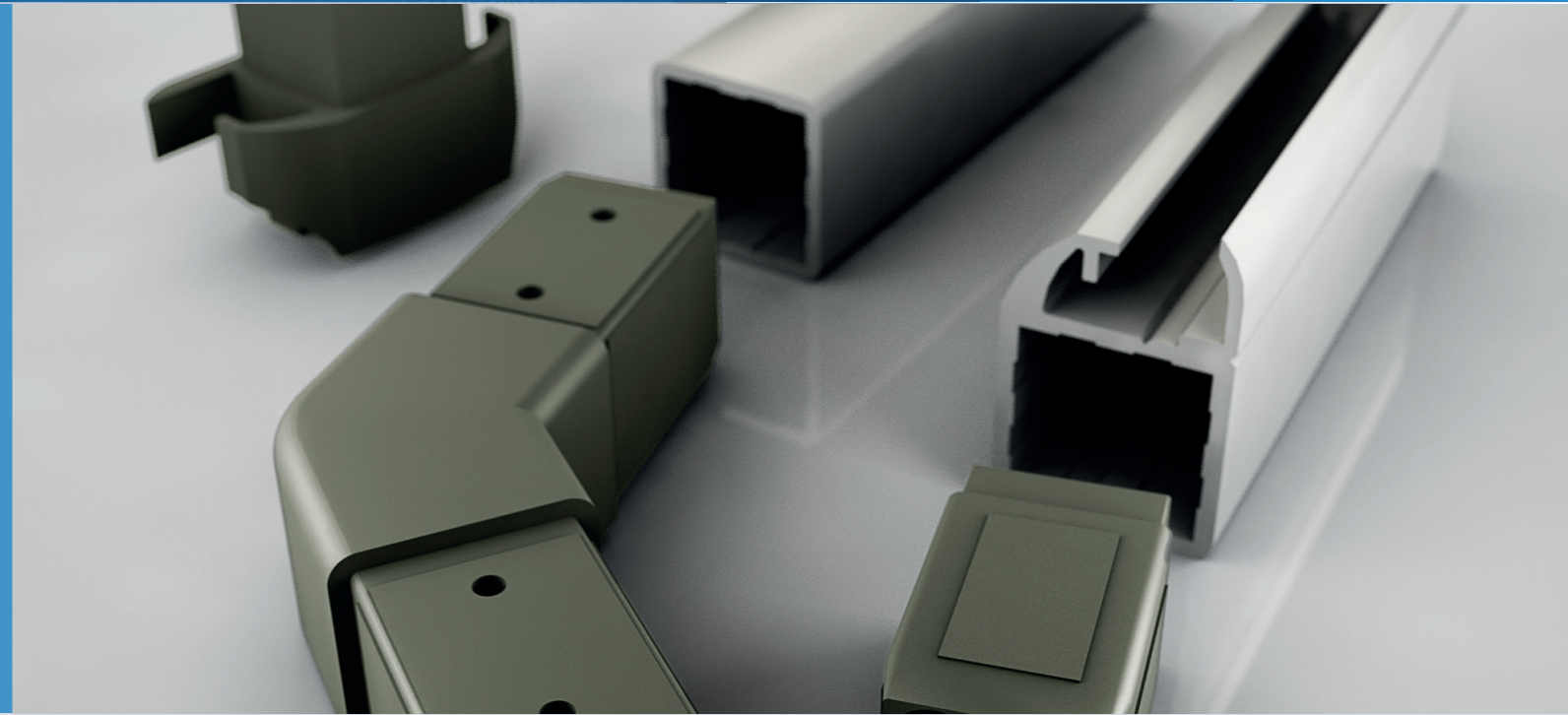

PROFILI SERIE 25

Profile Serie 25

I profili e i componenti Serie 25 nascono dall'esigenza di avere ingombri contenuti sulla struttura del pannello ma allo stesso tempo garantire una vasta gamma di scelta di soluzioni di montaggio. In questa serie di profili si può optare per la soluzione SENZA GUARNIZIONE; le sezioni di questi profili sono state studiate e ottimizzate per compensare la mancanza di guarnizione con la forma geometrica del profilo. Per aumentare la stabilità delle strutture sono stati introdotti i profili a spessore 4 mm.

Series 25 profiles and components arise from the need to have limited dimensions on the panel structure but at the same time guarantee a wide range of choice of assembly solutions. In this series of profiles you can choose the solution WITHOUT GASKET; the sections of these profiles have been studied and optimized to compensate for the lack of gasket with the geometric shape of the profile. To increase the stability of the structures, 4 mm thick profiles have been introduced.

N.B. Tutte le immagini di questo catalogo sono rendering realizzati dai disegni 3D degli articoli raffigurati, pertanto il colore del materiale in queste immagini potrebbe non corrispondere esattamente alla tonalità reale degli articoli.
Per qualsiasi informazione contattare info@dierre.eu

N.B.: All images in this catalogue are renderings made from 3D drawings of the items depicted, therefore the colour of the material in these images may not exactly match the actual shade of the items.
For any information contact info@dierre.eu

Profilato 25-4R / Profile 25-4R

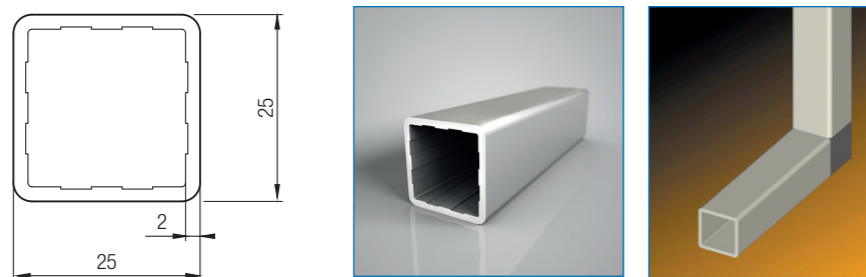

Caratteristiche tecniche / Technical features

Materiale / Material	Codice / Code	Peso (kg/mt) / Weight (kg/m)
Alluminio anodizzato ELOX / ELOX anodized aluminium	BPRDD0000307 / XB25125E	0,460
Alluminio anodizzato ARGENTO / SILVER anodized aluminium	BPRDD0000306 / XB25125	0,460
Lunghezza barra 6000 mm / Bar length 6000 mm		

Profilato 25-1V tamponato / Buffer profile 25-1V

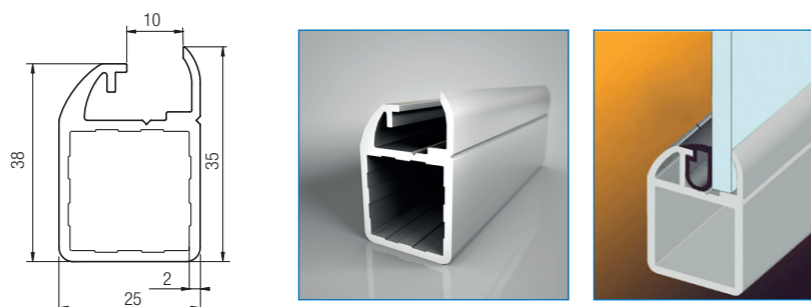

Caratteristiche tecniche / Technical features

Materiale / Material	Codice / Code	Peso (kg/mt) / Weight (kg/m)
Alluminio anodizzato ELOX / ELOX anodized aluminium	BPRDD0000293 / XB25525E	0,673
Alluminio anodizzato ARGENTO / SILVER anodized aluminium	BPRDD0000292 / XB25525	0,673
Lunghezza barra 6000 mm / Bar length 6000 mm		

Profilato 25-2VL tamponato / Buffer profile 25-2VL

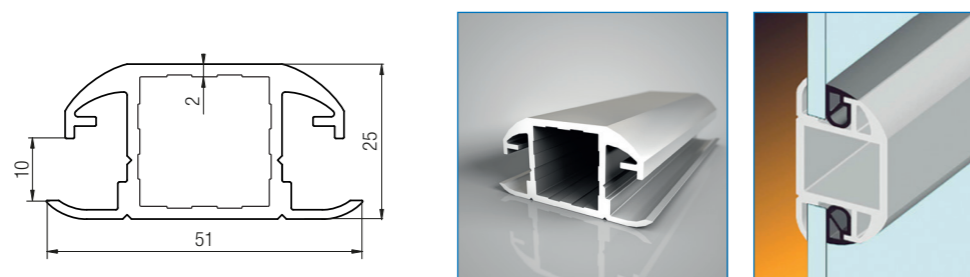

Caratteristiche tecniche / Technical features

Materiale / Material	Codice / Code	Peso (kg/mt) / Weight (kg/m)
Alluminio anodizzato ELOX / ELOX anodized aluminium	BPRDD0000303 / XB25526E	0,866
Alluminio anodizzato ARGENTO / SILVER anodized aluminium	BPRDD0000302 / XB25526	0,866
Lunghezza barra 6000 mm / Bar length 6000 mm		

Profilato 25-2VA tamponato / Buffer profile 25-2VA

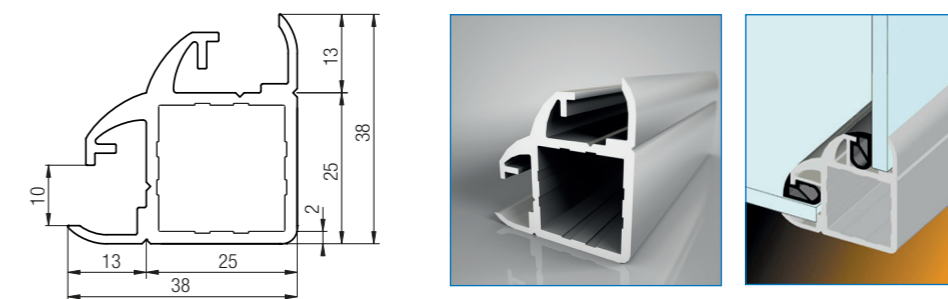

Caratteristiche tecniche / Technical features

Materiale / Material	Codice / Code	Peso (kg/mt) / Weight (kg/m)
Alluminio anodizzato ELOX / ELOX anodized aluminium	BPRDD0000297 / XB25527E	0,806
Alluminio anodizzato ARGENTO / SILVER anodized aluminium	BPRDD0000296 / XB25527	0,806
Lunghezza barra 6000 mm / Bar length 6000 mm		

Profilato fulcro per soffietto / Fulcrum profile for bellows

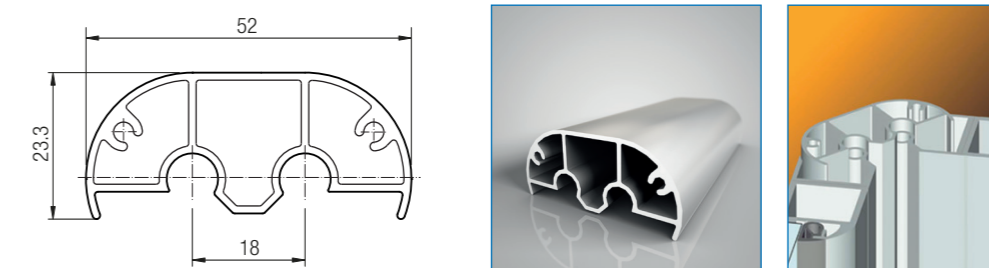

Caratteristiche tecniche / Technical features

Materiale / Material	Codice / Code	Peso (kg/mt) / Weight (kg/m)
Alluminio anodizzato ELOX / ELOX anodized aluminium	BPRDD0000305 / XB26531E	0,657
Alluminio anodizzato ARGENTO / SILVER anodized aluminium	BPRDD0000304 / XB26531	0,657
Lunghezza barra 6000 mm / Bar length 6000 mm		

Cornice fulcro soffietto / Bellows fulcrum frame

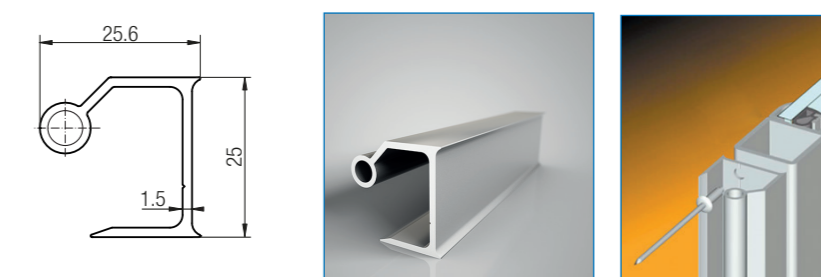

Caratteristiche tecniche / Technical features

Materiale / Material	Codice / Code	Peso (kg/mt) / Weight (kg/m)
Alluminio anodizzato ELOX / ELOX anodized aluminium	BPRDD0000255 / XB26532E	0,305
Alluminio anodizzato ARGENTO / SILVER anodized aluminium	BPRDD0000254 / XB26532	0,305
Lunghezza barra 6000 mm / Bar length 6000 mm		

Tappo per fulcro soffietto / Cap for bellows fulcrum

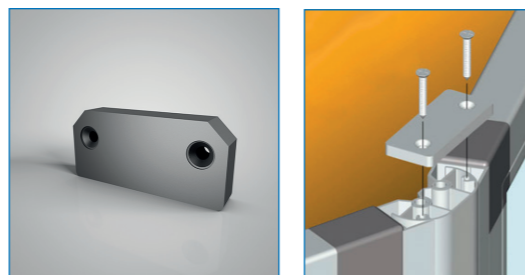
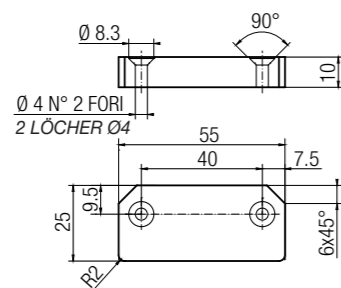

Caratteristiche tecniche / Technical features

Materiale / Material	Codice / Code	Peso (gr) / Weight (g)
PVC Grigio / Grey PVC	DTPXX0000016 / XT90040	10,50
Confezione da 20 Pz. / Pack of 20 Pcs.		

Cornice 25 tamponato / Buffer frame 25

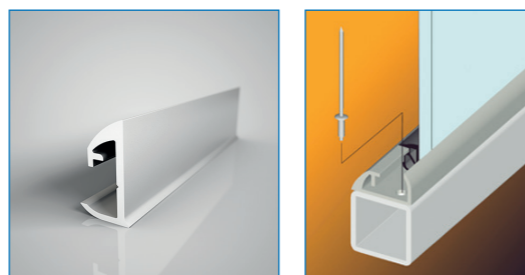
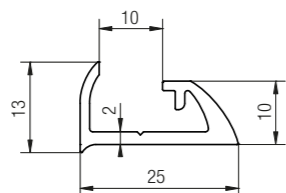

Caratteristiche tecniche / Technical features

Materiale / Material	Codice / Code	Peso (kg/mt) / Weight (kg/m)
Alluminio anodizzato ELOX / ELOX anodized aluminium	BPRDD0000258 / XB26125E	0,265
Alluminio anodizzato ARGENTO / SILVER anodized aluminium	BPRDD0000257 / XB26125	0,265
Lunghezza barra 6000 mm / Bar length 6000 mm		

Cornice tenuta per sportello / Frame seal for hatch

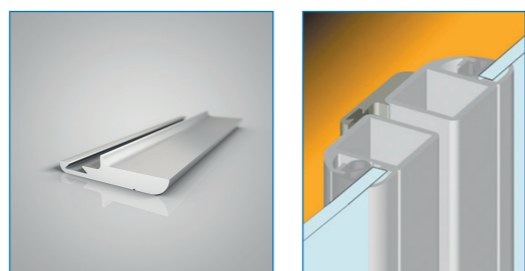
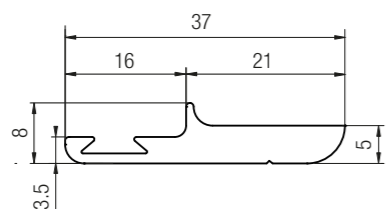

Caratteristiche tecniche / Technical features

Materiale / Material	Codice / Code	Peso (kg/mt) / Weight (kg/m)
Alluminio anodizzato ELOX / ELOX anodized aluminium	BPRDD0000267 / XB27105E	0,390
Alluminio anodizzato ARGENTO / SILVER anodized aluminium	BPRDD0000266 / XB27105	0,390
Lunghezza barra 6000 mm / Bar length 6000 mm		

Profilo Q25/1V SENZA GUARNIZIONE sp.2 / Profile Q25/1V WITHOUT GASKET thk. 2

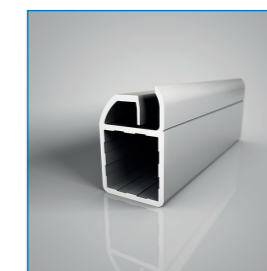
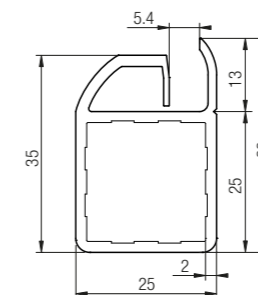

Caratteristiche tecniche / Technical features

Materiale / Material	Codice / Code	Peso (kg/mt) / Weight (kg/m)
Alluminio anodizzato ELOX / ELOX anodized aluminium	BPRDD0000289 / XB28525E	0,673
Alluminio anodizzato ARGENTO / SILVER anodized aluminium	BPRDD0000290 / XB28525	0,673
Lunghezza barra 6000 mm / Bar length 6000 mm		

Profilo Q25/2VL SENZA GUARNIZIONE sp.2 / Profile Q25/2VL WITHOUT GASKET thk. 2

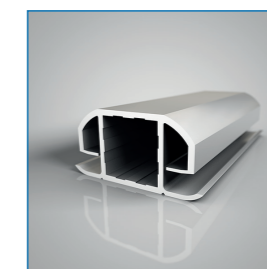
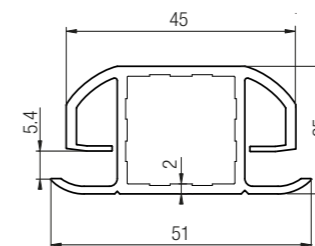

Caratteristiche tecniche / Technical features

Materiale / Material	Codice / Code	Peso (kg/mt) / Weight (kg/m)
Alluminio anodizzato ARGENTO / SILVER anodized aluminium	BPRDD0000300 / XB28526E	0,866
Alluminio anodizzato ELOX / ELOX anodized aluminium	BPRDD0000301 / XB28526	0,866
Lunghezza barra 6000 mm / Bar length 6000 mm		

Profilo Q.25VA SENZA GUARNIZIONE sp.2 / Profile Q25/2VA WITHOUT GASKET thk. 2

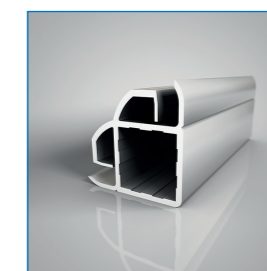
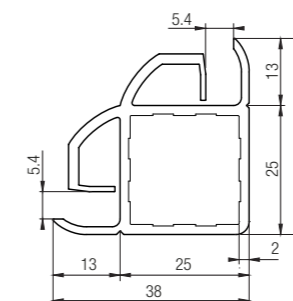

Caratteristiche tecniche / Technical features

Materiale / Material	Codice / Code	Peso (kg/mt) / Weight (kg/m)
Alluminio anodizzato ELOX / ELOX anodized aluminium	BPRDD0000295 / XB28527E	0,806
Alluminio anodizzato ARGENTO / SILVER anodized aluminium	BPRDD0000294 / XB28527	0,806
Lunghezza barra 6000 mm / Bar length 6000 mm		

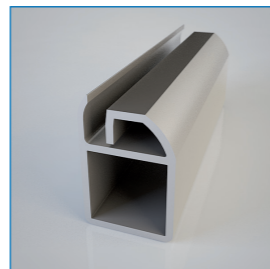
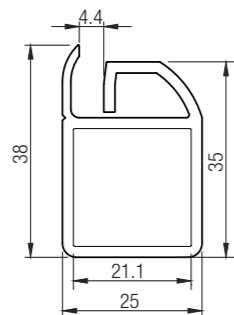
Profilo Q25/1V SENZA GUARNIZIONE sp.4 / Profile Q25/1V WITHOUT GASKET thk. 4

Caratteristiche tecniche / Technical features

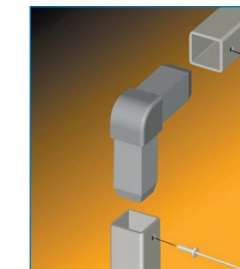
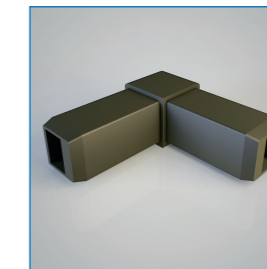
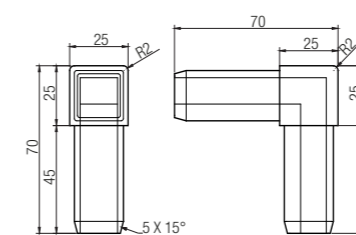
Materiale / Material	Codice / Code	Peso (kg/mt) / Weight (kg/m)
Alluminio anodizzato ELOX / ELOX anodized aluminium	BPRDD0000288 / XB28425E	0,632
Alluminio anodizzato ARGENTO / SILVER anodized aluminium	BPRDD0000287 / XB28425	0,632
Lunghezza barra 6000 mm / Bar length 6000 mm		

Giunzione 25-2VA / Connection 25-2VA

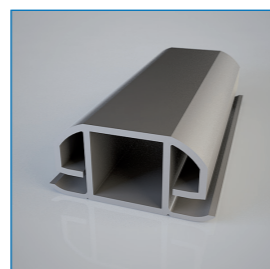
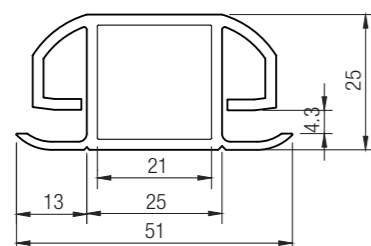
Caratteristiche tecniche / Technical features

Materiale / Material	Codice / Code	Peso (gr) / Weight (g)
Nylon RAL 7039 / Nylon RAL 7039	DGIPD0000036 / XF30102G	36,50
Confezione da 100 Pz. / Pack of 100 Pcs.		

Profilo Q25/2VL SENZA GUARNIZIONE sp.4 / Profile Q25/2VL WITHOUT GASKET thk. 4

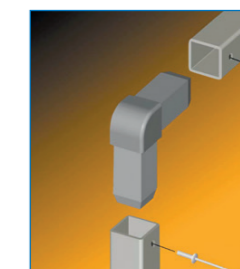
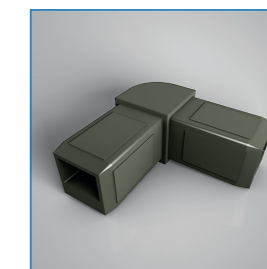
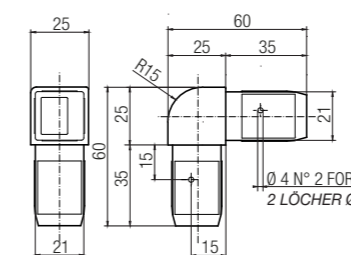
Caratteristiche tecniche / Technical features

Materiale / Material	Codice / Code	Peso (kg/mt) / Weight (kg/m)
Alluminio anodizzato ELOX / ELOX anodized aluminium	BPRDD0000299 / XB28426E	0,855
Alluminio anodizzato ARGENTO / SILVER anodized aluminium	BPRDD0000298 / XB28426	0,855
Lunghezza barra 6000 mm / Bar length 6000 mm		

Giunzione 25-2VA R15 rinforzata / Reinforced connection 25-2VA R15

Caratteristiche tecniche / Technical features

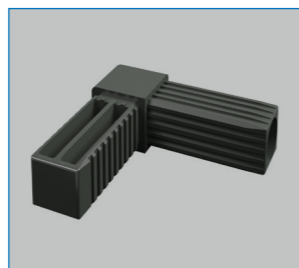
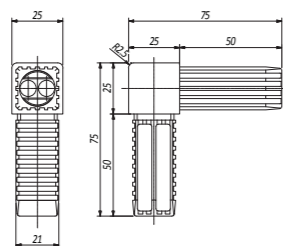
Materiale / Material	Codice / Code	Peso (gr) / Weight (g)
Nylon RAL 7039 / Nylon RAL 7039	DGIPD0000011 / XF30105G	60,00
Confezione da 100 Pz. / Pack of 100 Pcs.		

Giunzione Q.25-2VA GR Ivory GV6H RAL 7039 / Connection Q.25-2VA GR Ivory GV6H RAL 7039



Caratteristiche tecniche / Technical features

Materiale / Material	Codice / Code	Peso (gr) / Weight (g)
Nylon RAL 7039 / Nylon RAL 7039	DGIPD000130	40,00
Confezione da 100 Pz. / Pack of 100 Pcs.		

Giunzione 25-2VA senza smusso forata DX/SX / 25-2VA Connection without RH/LH drilled bevel

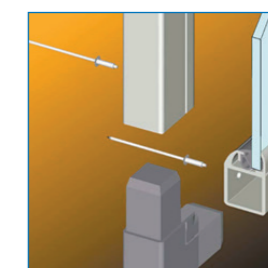
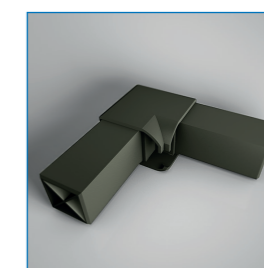
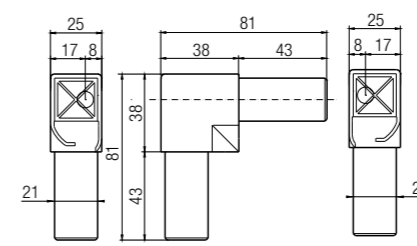

Caratteristiche tecniche / Technical features

Materiale / Material	Codice / Code	Peso (gr) / Weight (g)
Nylon RAL 7039 DX / Nylon RAL 7039 RH	DGIPD0000041 / XT40112G1	53,00
Nylon RAL 7039 SX / Nylon RAL 7039 LH	DGIPD0000031 / XT40113G1	53,00
Confezione da 100 Pz. / Pack of 100 Pcs.		

GIUNZIONE Q25-2VL S/GUARNIZIONE / Q25-2VL CONNECTION W/OUT GASKET

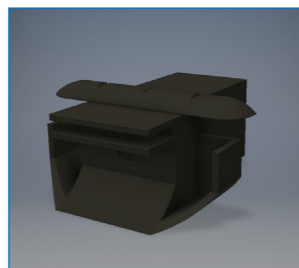
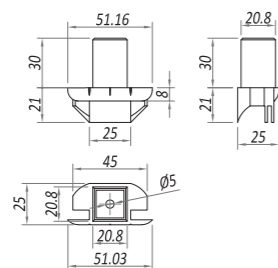

Caratteristiche tecniche / Technical features

Materiale / Material	Codice / Code	Peso (gr) / Weight (g)
Nylon RAL 7039 / Nylon RAL 7039	DGIPD0000044 / XF30201G1	10,00
Confezione da 100 Pz. / Pack of 100 Pcs.		

Giunzione 25-3VA / Connection 25-3VA

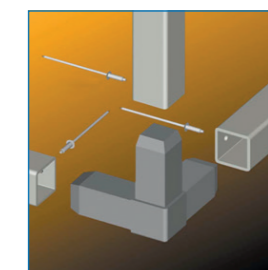
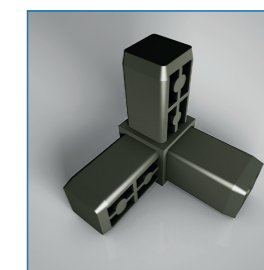
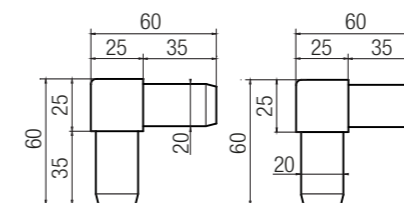

Caratteristiche tecniche / Technical features

Materiale / Material	Codice / Code	Peso (gr) / Weight (g)
Nylon RAL 7039 / Nylon RAL 7039	DGIPD0000048 / XF30103G	50,00
Confezione da 200 Pz. / Pack of 200 Pcs.		

Giunzione 25-2VA senza smusso rinforzata / 25-2VA Connection without reinforced bevel

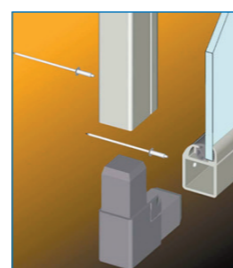
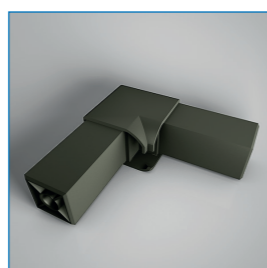
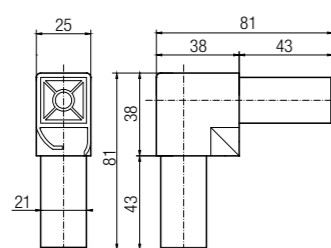

Caratteristiche tecniche / Technical features

Materiale / Material	Codice / Code	Peso (gr) / Weight (g)
Nylon RAL 7039 / Nylon RAL 7039	DGIPD0000040 / XF31502G1	55,00
Confezione da 100 Pz. / Pack of 100 Pcs.		

Giunzione 25-2VA 45° rinforzata / 25-2VA 45° Reinforced connection

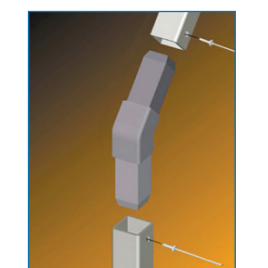
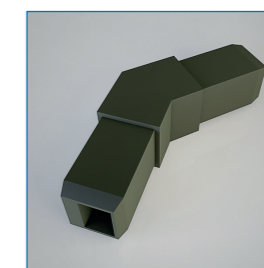
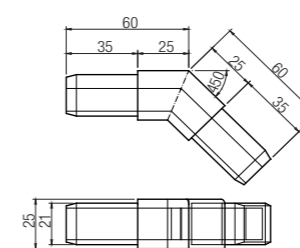

Caratteristiche tecniche / Technical features

Materiale / Material	Codice / Code	Peso (gr) / Weight (g)
Nylon RAL 7039 / Nylon RAL 7039	DGIPD0000010 / XF30506G	75,00
Confezione da 100 Pz. / Pack of 100 Pcs.		

Giunzione 25-2VL / Connection 25-2VL

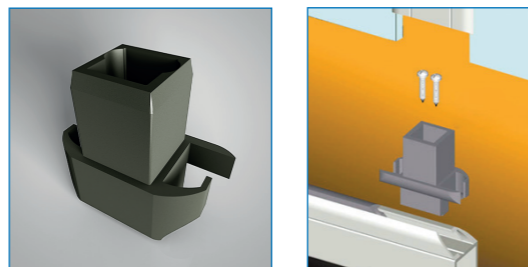
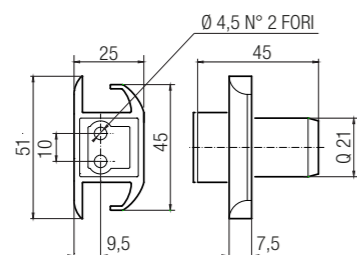

Caratteristiche tecniche / Technical features

Materiale / Material	Codice / Code	Peso (gr) / Weight (g)
Nylon RAL 7039 / Nylon RAL 7039	DGIPD0000043 / XF30201G	17,00
Confezione da 200 Pz. / Pack of 200 Pcs.		

Collarino giunzione 25 / 25 Connection collar

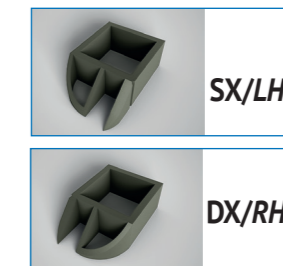
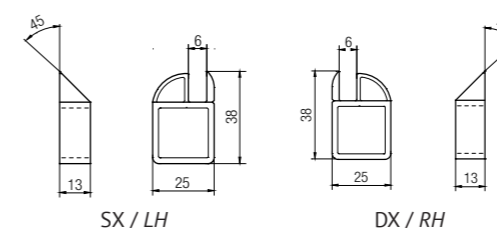

Caratteristiche tecniche / Technical features

Materiale / Material	Codice / Code	Peso (gr) / Weight (g)
Nylon RAL 7039 SX / Nylon RAL 7039 LH	DBOXX0000038 / XF62512G	2,00
Nylon RAL 7039 DX / Nylon RAL 7039 RH	DBOXX0000036 / XF62513G	2,00
Confezione da 200 Pz. / Pack of 200 Pcs.		

Giunzione 25-1V / Connection 25-1V

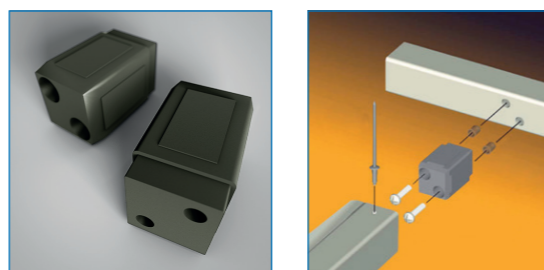
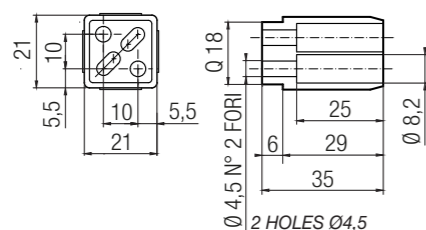

Caratteristiche tecniche / Technical features

Materiale / Material	Codice / Code	Peso (gr) / Weight (g)
Nylon RAL 7039 / Nylon RAL 7039	DGIPD0000029 / XF30101G	10,00
Confezione da 200 Pz. / Pack of 200 Pcs.		

Tappo tubolare 25 / 25 Tube cap

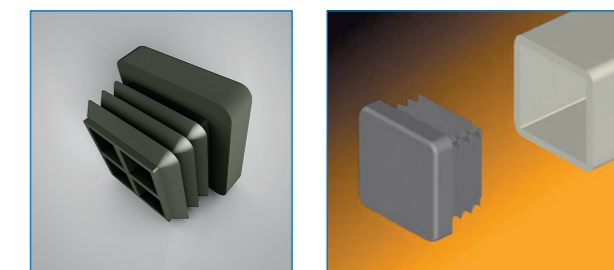
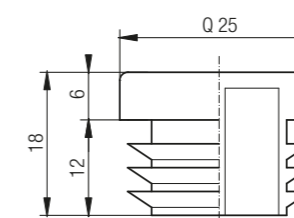

Caratteristiche tecniche / Technical features

Materiale / Material	Codice / Code	Peso (gr) / Weight (g)
Nylon Nero / Black nylon	CTPTU0000010 / XC30125	3,00
Nylon RAL 7039 / Nylon RAL 7039	CTPTU0000011 / XC30125G	3,00
Confezione da 100 Pz. / Pack of 200 Pcs.		

Collarino per giunzione 25-1V / 25-1V Connection collar

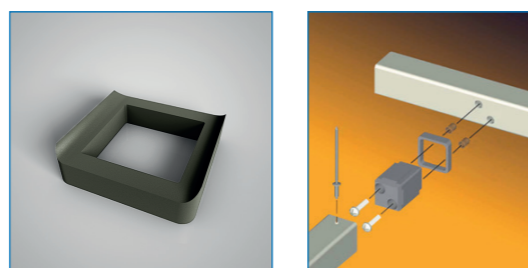
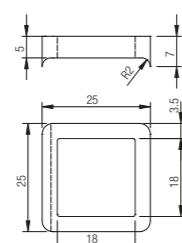

Caratteristiche tecniche / Technical features

Materiale / Material	Codice / Code	Peso (gr) / Weight (g)
Nylon RAL 7039 / Nylon RAL 7039	DBOXX0000041 / XF62501G	2,00
Confezione da 200 Pz. / Pack of 200 Pcs.		

Cornice per giunzione 25-2VA 90° / Frame for 25-2VA 90° connection

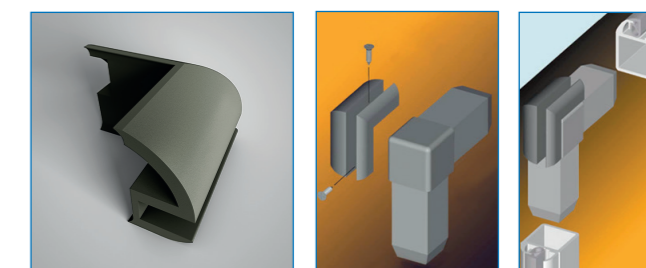
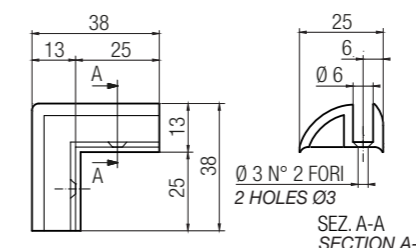

Caratteristiche tecniche / Technical features

Materiale / Material	Codice / Code	Peso (gr) / Weight (g)
Nylon RAL 7039 / Nylon RAL 7039	DGIPD0000003 / XF31112G	10,00
Confezione da 200 Pz. / Pack of 200 Pcs.		

Cornice per giunzione 25-2VA R15 / Frame for 25-2VA R15 connection

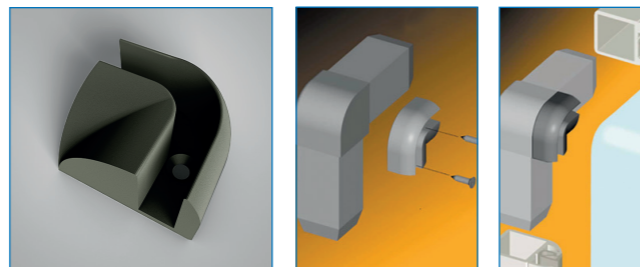
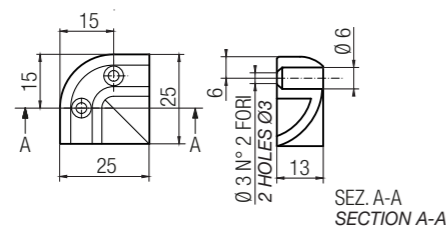

Caratteristiche tecniche / Technical features

Materiale / Material	Codice / Code	Peso (gr) / Weight (g)
Nylon RAL 7039 / Nylon RAL 7039	DGIPD0000008 / XF31115G	4,00
Confezione da 200 Pz. / Pack of 200 Pcs.		

Cornice per giunzione 25-2VA 45° / Frame for 25-2VA 45° connection

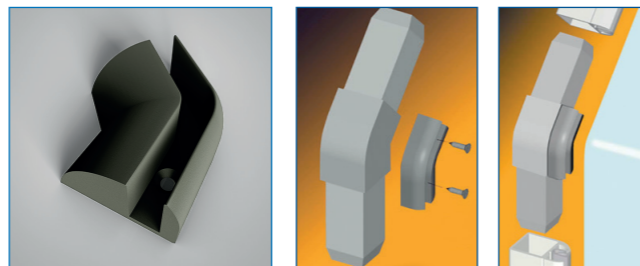
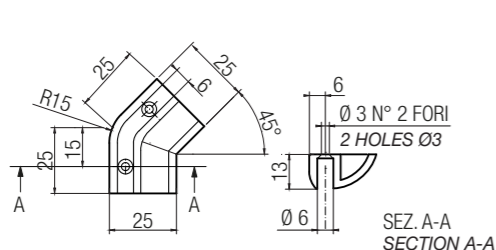

Caratteristiche tecniche / Technical features

Materiale / Material	Codice / Code	Peso (gr) / Weight (g)
Nylon RAL 7039 / Nylon RAL 7039	DGIPD0000007 / XF31117G	7,00
Confezione da 200 Pz. / Pack of 100 Pcs.		

Ruota con sede per cuscinetti L=19,5 / Wheel with bearing housing L=19.5

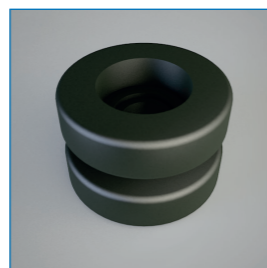
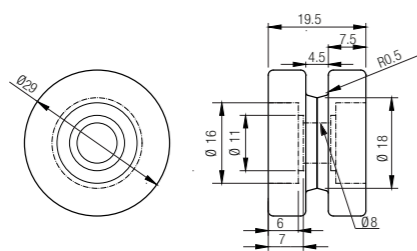

Caratteristiche tecniche / Technical features

Materiale / Material	Codice / Code	Peso (gr) / Weight (g)
Polizene nero / Black polyzene	DRUSC0000008 / XT90126	7,50
Confezione da 100 Pz. / Pack of 100 Pcs.		

Rondella D.14 sp. 2,5 per perno / D14 washer thk. 2,5 for pin

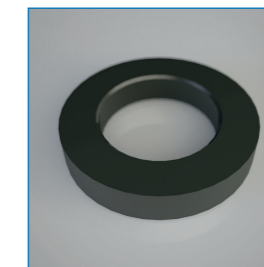
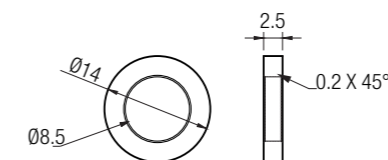

Caratteristiche tecniche / Technical features

Materiale / Material	Codice / Code	Peso (gr) / Weight (g)
Nylon nero / Black nylon	DROXX0000001 / XT90036	0,50
Confezione da 100 Pz. / Pack of 100 Pcs.		

Cuscinetto 618/8 sp.4 D.E. 16 D.I. 8 (ISB) / Bearing 618/8 thk. 4 Da 16 Di 8 (ISB)

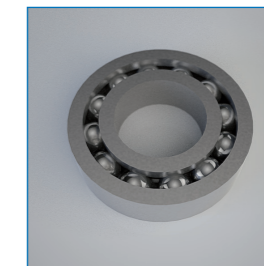
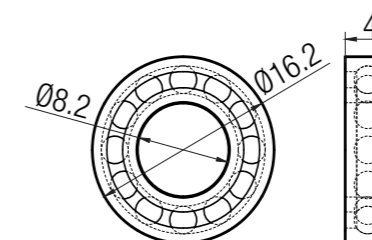

Caratteristiche tecniche / Technical features

Materiale / Material	Codice / Code	Peso (gr) / Weight (g)
Acciaio / Steel	CCUSE0000034 / XC60603	3,50
Confezione da 100 Pz. / Pack of 100 Pcs.		

Perno maschio per ruota / Male pin for wheel

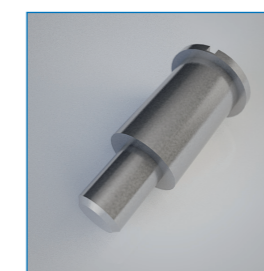
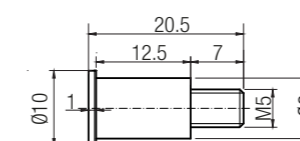

Caratteristiche tecniche / Technical features

Materiale / Material	Codice / Code	Peso (gr) / Weight (g)
Ferro zincato / Galvanized iron	DPEXX0000084 / XT90125	6,00
Confezione da 100 Pz. / Pack of 100 Pcs.		

Perno femmina per ruota / Female pin for wheel

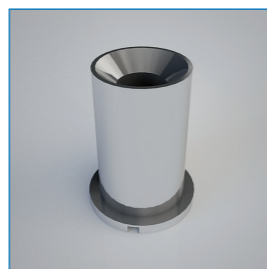
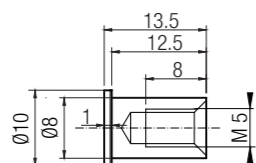

Caratteristiche tecniche / Technical features

Materiale / Material	Codice / Code	Peso (gr) / Weight (g)
Ferro zincato / Galvanized iron	DPEXX0000062 / XT90127	3,50
Confezione da 100 Pz. / Pack of 100 Pcs.		

Giunzione Q.35-2VA orientabile / Adjustable Q.35-2VA connection

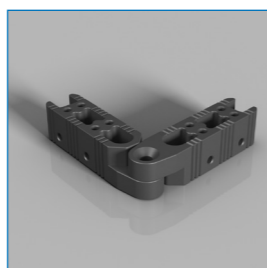
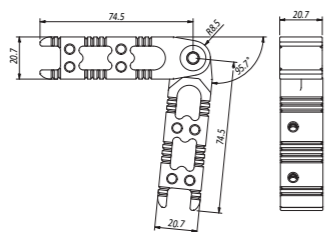

Caratteristiche tecniche / Technical features

Materiale / Material	Codice / Code	Peso (gr) / Weight (g)
Alluminio / Aluminium	DGIPD0000219	100
Confezione da 100 Pz. / Pack of 100 Pcs.		

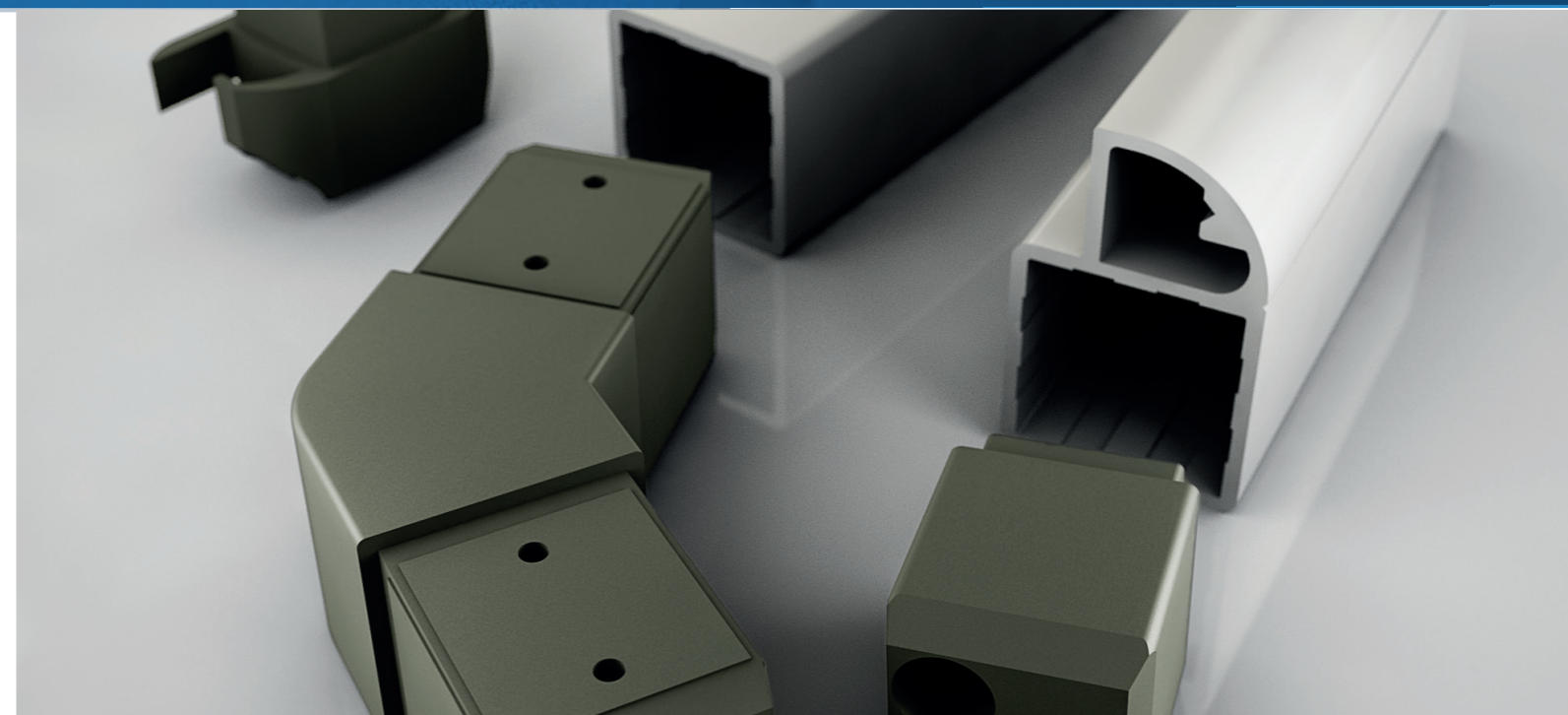

PROFILI SERIE 30 SERIES 30 PROFILES

I profili e i componenti Serie 30 propongono la più vasta gamma di sezioni e tipologie di profilo. Anche questa serie di profili si può optare per la soluzione SENZA GUARNIZIONE; le sezioni di questi profili sono state studiate e ottimizzate per compensare la mancanza di guarnizione con la forma geometrica del profilo.

Come per i profili serie 25 anche questa gamma di profili sono proposti con spessori di 4mm che sommati alle maggiori dimensioni della sezione vanno ad aumentare ancorà di più la stabilità e la rigidità delle strutture.

Series 30 profiles and components offer the widest range of profile sections and types.

In this series of profiles you can also choose the solution WITHOUT GASKET; the sections of these profiles have been studied and optimized to compensate for the lack of gasket with the geometric shape of the profile.

Just like for the 25 series profiles, this range of profiles are also offered with thicknesses of 4mm which, added to the greater dimensions of the section, further increase the stability and rigidity of the structures.

N.B. Tutte le immagini di questo catalogo sono rendering realizzati dai disegni 3D degli articoli raffigurati, pertanto il colore del materiale in queste immagini potrebbe non corrispondere esattamente alla tonalità reale degli articoli. Per qualsiasi informazione contattare info@dierre.eu

N.B.: All images in this catalogue are renderings made from 3D drawings of the items depicted, therefore the colour of the material in these images may not exactly match the actual shade of the items. For any information contact info@dierre.eu

Profilato 30-4R / Profile 30-4R

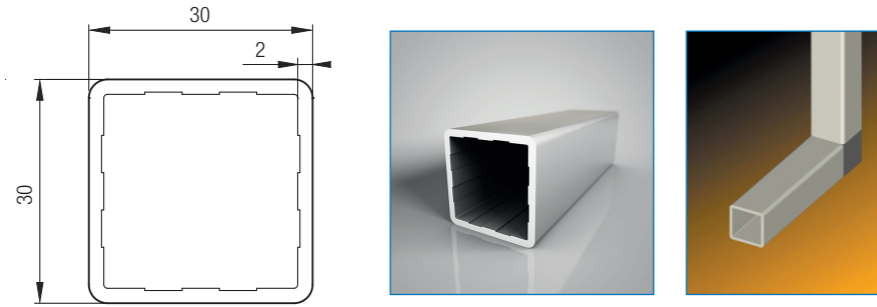

Caratteristiche tecniche / Technical features

Materiale / Material	Codice / Code	Peso (kg/mt) / Weight (kg/m)
Alluminio anodizzato ELOX / ELOX anodized aluminium	BPRDD0000331 / XB25130E	0,566
Alluminio anodizzato ARGENTO / SILVER anodized aluminium	BPRDD0000330 / XB25130	0,566
Lunghezza barra 6000 mm / Bar length 6000 mm		

Prof. Q30 1v C/Guarn. C/cava all. argento / Q30 1v Prof. w/gasket hollow silver al.

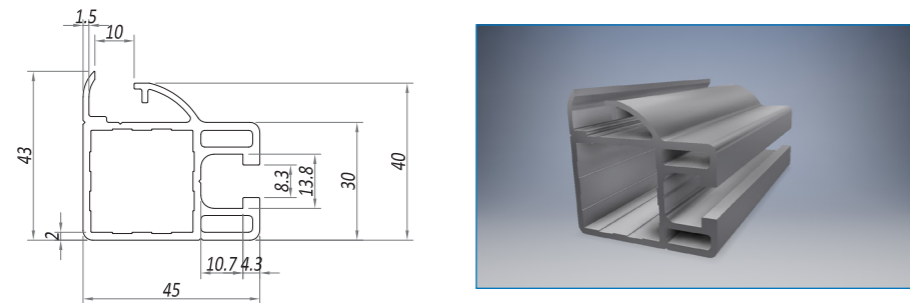

Caratteristiche tecniche / Technical features

Materiale / Material	Codice / Code	Peso (kg/mt) / Weight (kg/m)
Alluminio anodizzato ARGENTO / SILVER anodized aluminium	BPRDD0000543	1
Lunghezza barra 6000 mm / Bar length 6000 mm		

Profilato 30-1V tamponato / 30-1V Buffer profile

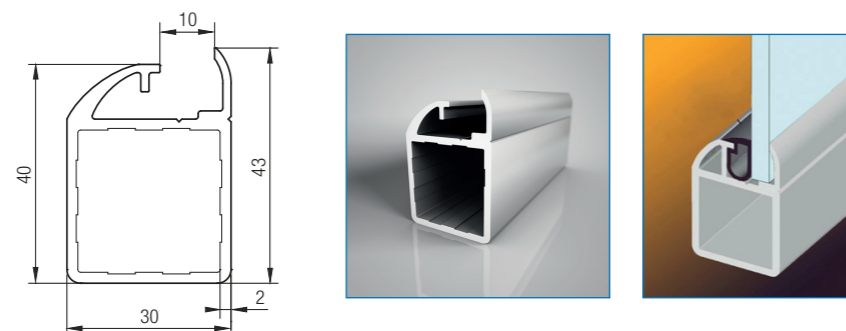

Caratteristiche tecniche / Technical features

Materiale / Material	Codice / Code	Peso (kg/mt) / Weight (kg/m)
Alluminio anodizzato ELOX / ELOX anodized aluminium	BPRDD0000308 / XB25530E	0,789
Alluminio anodizzato ARGENTO / SILVER anodized aluminium	BPRDD0000314 / XB25530	0,789
Lunghezza barra 6000 mm / Bar length 6000 mm		

Profilato 30-2VA tamponato / 30-2VA Buffer profile

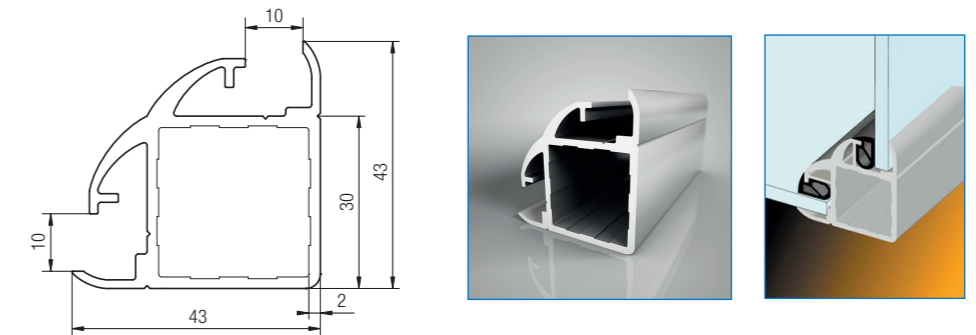

Caratteristiche tecniche / Technical features

Materiale / Material	Codice / Code	Peso (kg/mt) / Weight (kg/m)
Alluminio anodizzato ELOX / ELOX anodized aluminium	BPRDD0000318 / XB25531E	0,945
Alluminio anodizzato ARGENTO / SILVER anodized aluminium	BPRDD0000317 / XB25531	0,945
Lunghezza barra 6000 mm / Bar length 6000 mm		

Profilato 30-2VL tamponato / 30-2VL Buffer profile

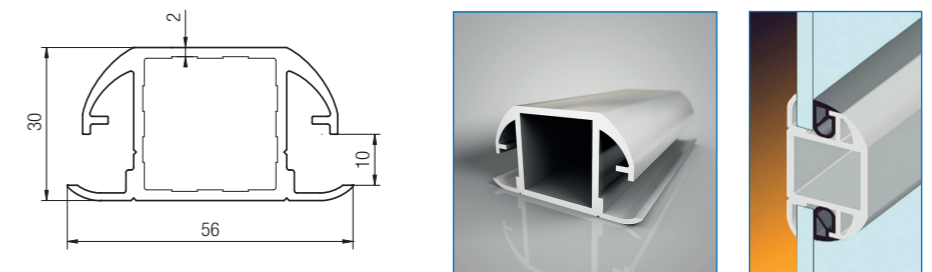

Caratteristiche tecniche / Technical features

Materiale / Material	Codice / Code	Peso (kg/mt) / Weight (kg/m)
Alluminio anodizzato ELOX / ELOX anodized aluminium	BPRDD0000325 / XB25532E	0,945
Alluminio anodizzato ARGENTO / SILVER anodized aluminium	BPRDD0000324 / XB25532	0,945
Lunghezza barra 6000 mm / Bar length 6000 mm		

Profilato 30 tenuta per sportello / Profile 30 seal for hatch

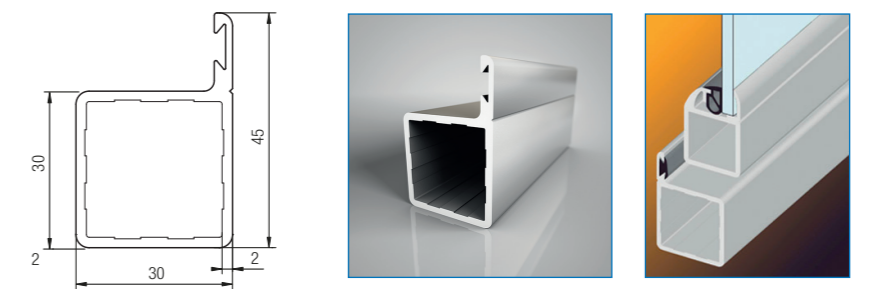

Caratteristiche tecniche / Technical features

Materiale / Material	Codice / Code	Peso (kg/mt) / Weight (kg/m)
Alluminio anodizzato ELOX / ELOX anodized aluminium	BPRDD0000344 / XB25930E	0,650
Alluminio anodizzato ARGENTO / SILVER anodized aluminium	BPRDD0000343 / XB25930	0,650
Lunghezza barra 6000 mm / Bar length 6000 mm		

Profilato 30 tenuta alta per sportello 25 / Profile 30 high seal for hatch 25

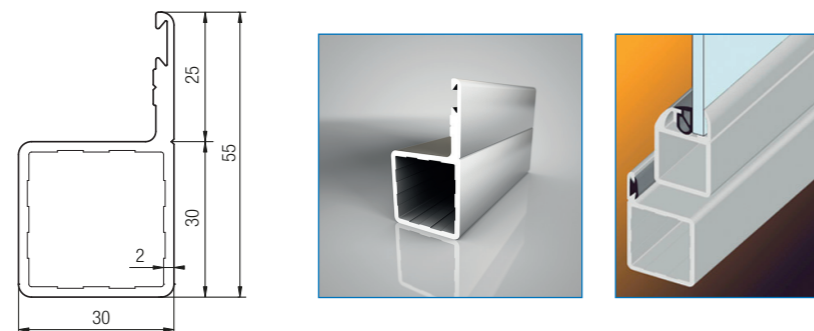

Caratteristiche tecniche / Technical features

Materiale / Material	Codice / Code	Peso (kg/mt) / Weight (kg/m)
Alluminio anodizzato ELOX / ELOX anodized aluminium	BPRDD0000234 / XB25931E	0,700
Alluminio anodizzato ARGENTO / SILVER anodized aluminium	BPRDD0000233 / XB25931	0,700
Lunghezza barra 6000 mm / Bar length 6000 mm		

Profilato 30 soffietto positivo / Profile 30 positive bellows

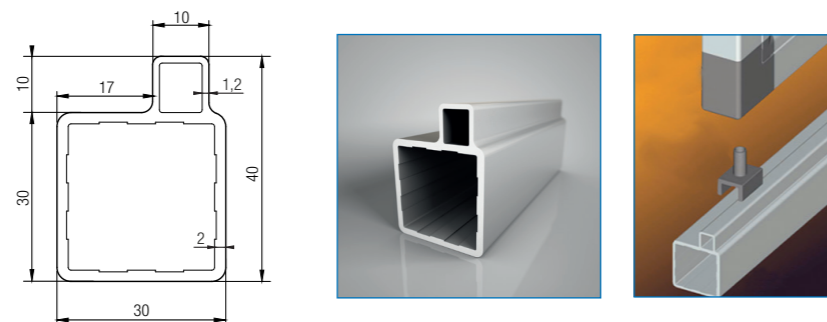

Caratteristiche tecniche / Technical features

Materiale / Material	Codice / Code	Peso (kg/mt) / Weight (kg/m)
Alluminio anodizzato ELOX / ELOX anodized aluminium	BPRDD0000342 / XB26533E	0,677
Alluminio anodizzato ARGENTO / SILVER anodized aluminium	BPRDD0000341 / XB26533	0,677
Lunghezza barra 6000 mm / Bar length 6000 mm		

Profilato a vista / Visible profile

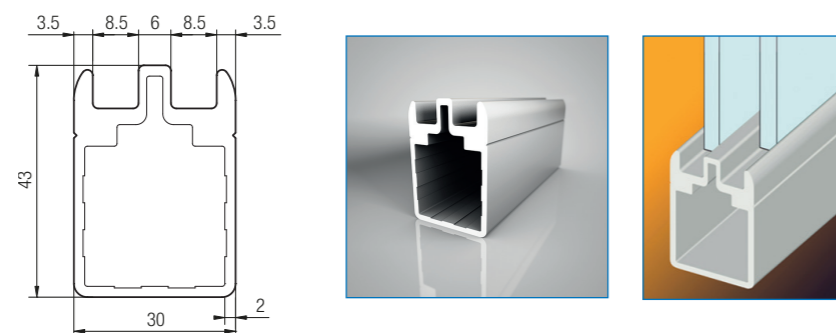

Caratteristiche tecniche / Technical features

Materiale / Material	Codice / Code	Peso (kg/mt) / Weight (kg/m)
Alluminio anodizzato ELOX / ELOX anodized aluminium	BPRDD0000337 / XB26630E	1,080
Alluminio anodizzato ARGENTO / SILVER anodized aluminium	BPRDD0000336 / XB26630	1,080
Lunghezza barra 6000 mm / Bar length 6000 mm		

Profilato 30 materiale plastico asportabile / Profile 30 removable plastic material

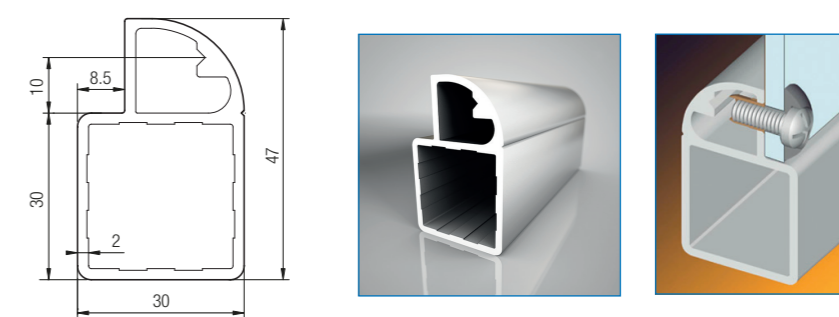

Caratteristiche tecniche / Technical features

Materiale / Material	Codice / Code	Peso (kg/mt) / Weight (kg/m)
Alluminio anodizzato ELOX / ELOX anodized aluminium	BPRDD0000335 / XB25533E	0,867
Alluminio anodizzato ARGENTO / SILVER anodized aluminium	BPRDD0000334 / XB25533	0,867
Lunghezza barra 6000 mm / Bar length 6000 mm		

Profilato 30 scorrevole positivo / Positive sliding profile 30

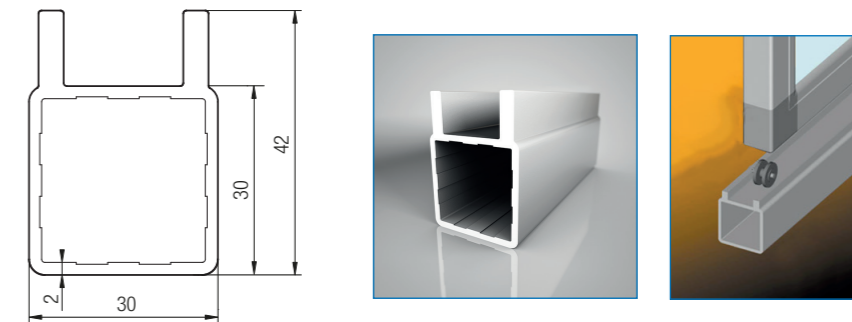

Caratteristiche tecniche / Technical features

Materiale / Material	Codice / Code	Peso (kg/mt) / Weight (kg/m)
Alluminio anodizzato ELOX / ELOX anodized aluminium	BPRDD0000339 / XB26631E	0,765
Alluminio anodizzato ARGENTO / SILVER anodized aluminium	BPRDD0000338 / XB26631	0,765
Lunghezza barra 6000 mm / Bar length 6000 mm		

Profilato 30x60 / Profile 30x60

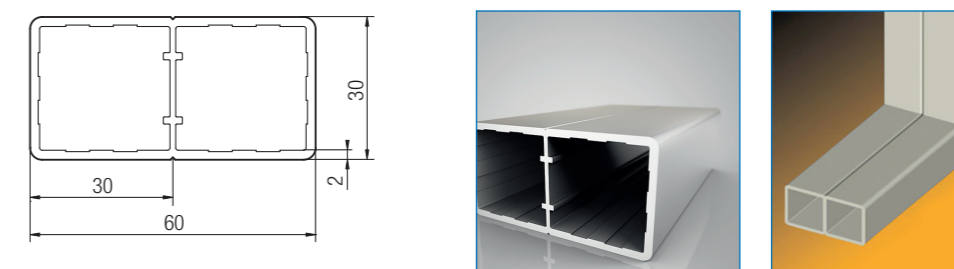

Caratteristiche tecniche / Technical features

Materiale / Material	Codice / Code	Peso (kg/mt) / Weight (kg/m)
Alluminio anodizzato ELOX / ELOX anodized aluminium	BPRDD0000244 / XB25160E	0,920
Alluminio anodizzato ARGENTO / SILVER anodized aluminium	BPRDD0000243 / XB25160	0,920
Lunghezza barra 6000 mm / Bar length 6000 mm		

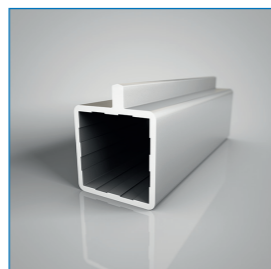
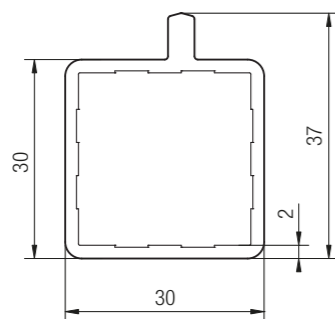
Profilato scorrevole 30x30 1 binario / Sliding profile 30x30 1 track

Caratteristiche tecniche / Technical features

Materiale / Material	Codice / Code	Peso (kg/mt) / Weight (kg/m)
Alluminio anodizzato ELOX / ELOX anodized aluminium	BPRDD0000232 / XB26632E	0,632
Alluminio anodizzato ARGENTO / SILVER anodized aluminium	BPRDD0000340 / XB26632	0,632

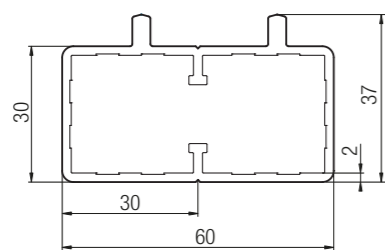
Lunghezza barra 6000 mm / Bar length 6000 mm

Profilato scorrevole 60x30 2 binari / Sliding profile 60x30 2 tracks

Caratteristiche tecniche / Technical features

Materiale / Material	Codice / Code	Peso (kg/mt) / Weight (kg/m)
Alluminio anodizzato ELOX / ELOX anodized aluminium	BPRDD0000239 / XB26662E	1,106
Alluminio anodizzato ARGENTO / SILVER anodized aluminium	BPRDD0000238 / XB26662	1,106

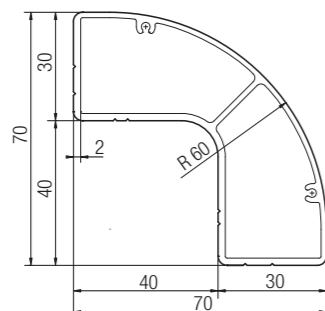
Lunghezza barra 6000 mm / Bar length 6000 mm

Profilato 30 raggiato / Radial profile 30

Caratteristiche tecniche / Technical features

Materiale / Material	Codice / Code	Peso (kg/mt) / Weight (kg/m)
Alluminio anodizzato ELOX / ELOX anodized aluminium	BPRDD0000347 / XB25170E	1,200
Alluminio anodizzato ARGENTO / SILVER anodized aluminium	BPRDD0000346 / XB25170	1,200

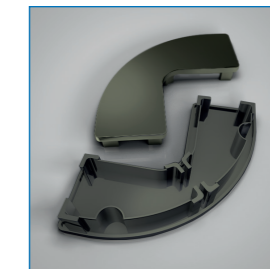
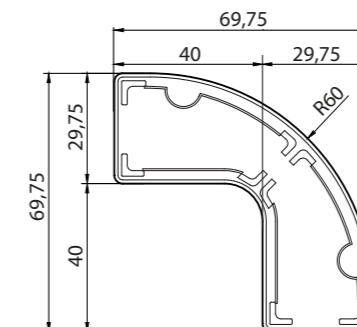
Lunghezza barra 6000 mm / Bar length 6000 mm

Tappo profilo raggiato / Radial profile cap

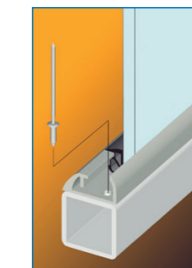
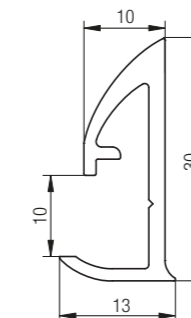
Caratteristiche tecniche / Technical features

Materiale / Material	Codice / Code	Peso (kg/mt) / Weight (kg/m)
Nylon RAL 7039 / Nylon RAL 7039	DTPTR0000085 / XT90042G	0,17

Cornice 30 tamponata / Buffer frame 30

Caratteristiche tecniche / Technical features

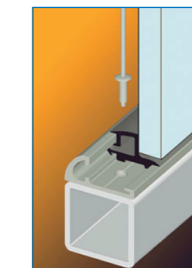
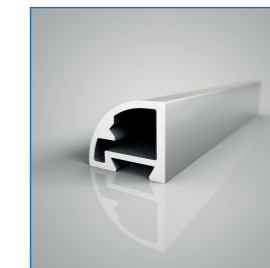
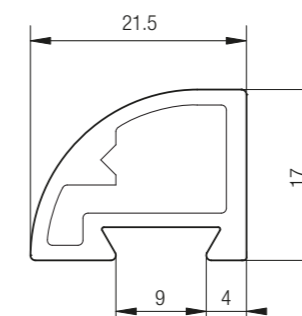
Materiale / Material	Codice / Code	Peso (kg/mt) / Weight (kg/m)
Alluminio anodizzato ELOX / ELOX anodized aluminium	BPRDD0000263 / XB26130E	0,306
Alluminio anodizzato ARGENTO / SILVER anodized aluminium	BPRDD0000264 / XB26130	0,306

Lunghezza barra 6000 mm / Bar length 6000 mm

Cornice 30 materiale plastico / Frame 30 plastic

Caratteristiche tecniche / Technical features

Materiale / Material	Codice / Code	Peso (kg/mt) / Weight (kg/m)
Alluminio anodizzato ELOX / ELOX anodized aluminium	BPRDD0000262 / XB26330E	0,450
Alluminio anodizzato ARGENTO / SILVER anodized aluminium	BPRDD0000261 / XB26330	0,450

Lunghezza barra 6000 mm / Bar length 6000 mm

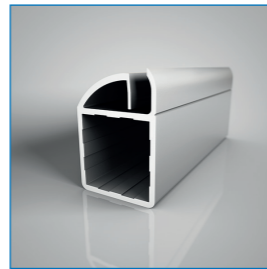
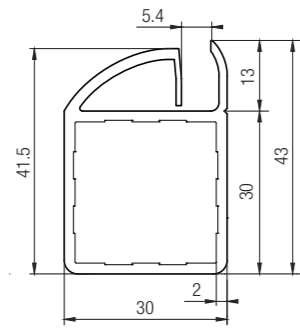
Profilo 30-1V SENZA GUARNIZIONE / Profile 30-1V WITHOUT GASKET



Caratteristiche tecniche / Technical features

Materiale / Material	Codice / Code	Peso (kg/mt) / Weight (kg/m)
Alluminio anodizzato ELOX / ELOX anodized aluminium	BPRDD0000312 / XB28530E	0,789
Alluminio anodizzato ARGENTO / SILVER anodized aluminium	BPRDD0000311 / XB28530	0,789
Lunghezza barra 6000 mm / Bar length 6000 mm		

Profilo Q. 30VA SENZA GUARNIZIONE / Profile Q. 30VA WITHOUT GASKET

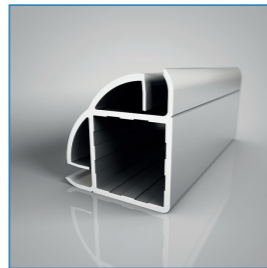
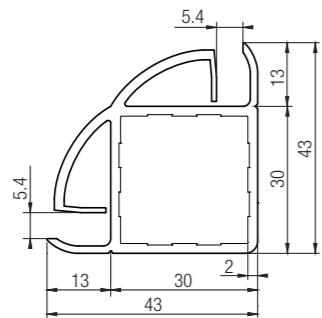

Caratteristiche tecniche / Technical features

Materiale / Material	Codice / Code	Peso (kg/mt) / Weight (kg/m)
Alluminio anodizzato ELOX / ELOX anodized aluminium	BPRDD0000231 / XB28531E	0,953
Alluminio anodizzato ARGENTO / SILVER anodized aluminium	BPRDD0000230 / XB28531	0,953
Lunghezza barra 6000 mm / Bar length 6000 mm		

Profilo Q.30 2VL SENZA GUARNIZIONE / Profile Q.30 2VL WITHOUT GASKET

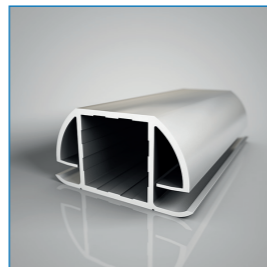
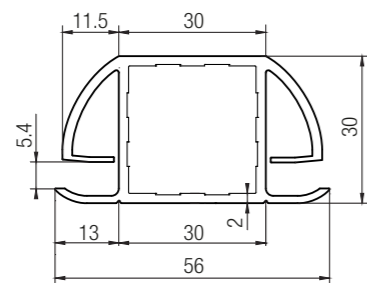

Caratteristiche tecniche / Technical features

Materiale / Material	Codice / Code	Peso (kg/mt) / Weight (kg/m)
Alluminio anodizzato ELOX / ELOX anodized aluminium	BPRDD0000323 / XB28532E	0,964
Alluminio anodizzato ARGENTO / SILVER anodized aluminium	BPRDD0000322 / XB28532	0,964
Lunghezza barra 6000 mm / Bar length 6000 mm		

Profilo 30-1V SENZA GUARNIZIONE sp.4 / Profile 30-1V WITHOUT GASKET thk. 4

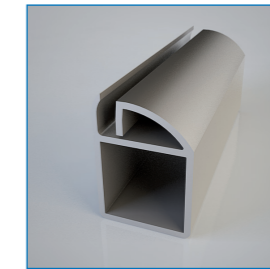
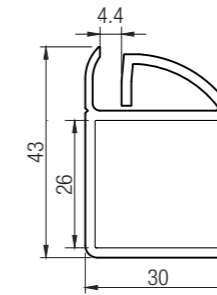

Caratteristiche tecniche / Technical features

Materiale / Material	Codice / Code	Peso (kg/mt) / Weight (kg/m)
Alluminio anodizzato ELOX / ELOX anodized aluminium	BPRDD0000310 / XB28430E	0,762
Alluminio anodizzato ARGENTO / SILVER anodized aluminium	BPRDD0000309 / XB28430	0,762
Lunghezza barra 6000 mm / Bar length 6000 mm		

Profilo 30 2VL SENZA GUARNIZIONE sp.4 / Profile 30 2VL WITHOUT GASKET thk. 4

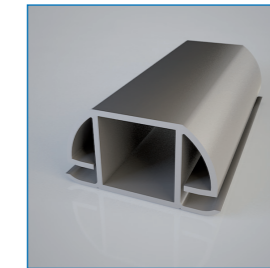
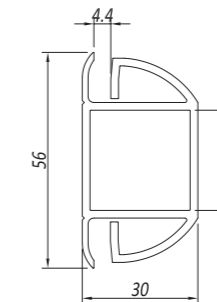

Caratteristiche tecniche / Technical features

Materiale / Material	Codice / Code	Peso (kg/mt) / Weight (kg/m)
Alluminio anodizzato ELOX / ELOX anodized aluminium	BPRDD0000321 / XB28432E	1,038
Alluminio anodizzato ARGENTO / SILVER anodized aluminium	BPRDD0000320 / XB28432	1,038
Lunghezza barra 6000 mm / Bar length 6000 mm		

Profilo Alluminio per cerniera 70x17 / Aluminium profile for hinge 70x17

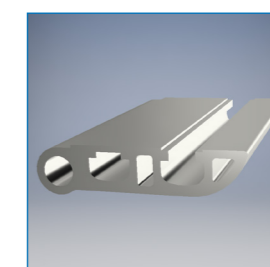
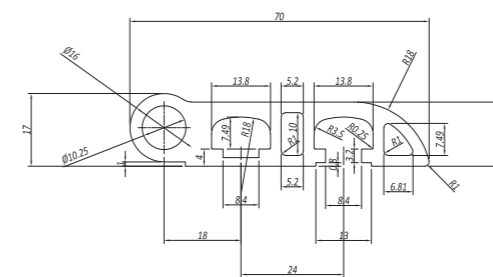

Caratteristiche tecniche / Technical features

Materiale / Material	Codice / Code	Peso (kg/mt) / Weight (kg/m)
Alluminio anodizzato ELOX / ELOX anodized aluminium	BPRCR0000027	1,510
Alluminio anodizzato ARGENTO / SILVER anodized aluminium	BPRCR0000028	1,510
Lunghezza barra 6040 mm / Bar length 6040 mm		

Giunzione Q.30-3VA GRl Ivory GV6H RAL 7039 / Connection 30-3VA GRl Ivory GV6H RAL 7039

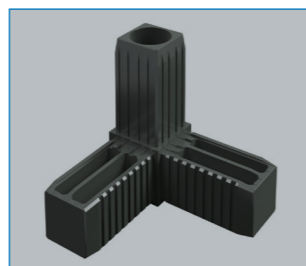
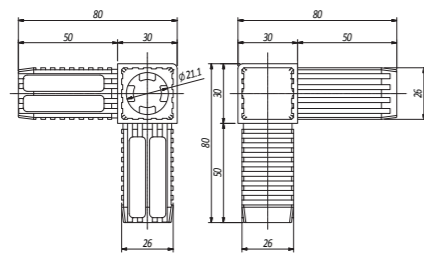

Caratteristiche tecniche / Technical features

Materiale / Material	Codice / Code	Peso (gr) / Weight (g)
Nylon RAL 7039 / Nylon RAL 7039	DGIPD0000131	100,00
Confezione da Pz. 100 / Pack of 100 Pcs.		

GIUNZIONE Q30-2VL S/GUARNIZIONE / Connection Q30-2VL W/OUT GASKET

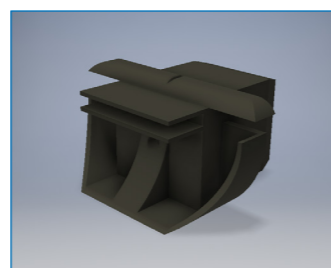
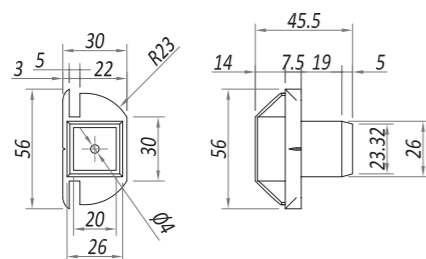

Caratteristiche tecniche / Technical features

Materiale / Material	Codice / Code	Peso (gr) / Weight (g)
Nylon RAL 7039 / Nylon RAL 7039	DGIPD0000057 / XF35201G1	20,00
Confezione da Pz. 200 / Pack of 200 Pcs.		

Giunzione 30-2VL / Connection 30-2VL

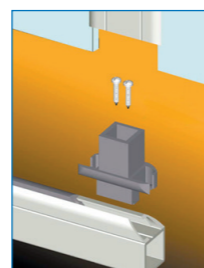
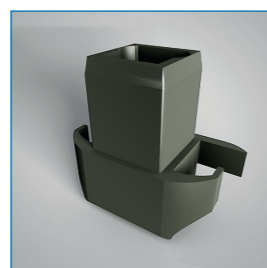
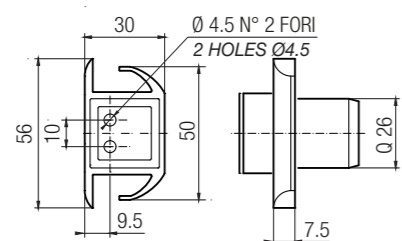

Caratteristiche tecniche / Technical features

Materiale / Material	Codice / Code	Peso (gr) / Weight (g)
Nylon RAL 7039 / Nylon RAL 7039	DGIPD0000018 / XF35201G	22,00
Confezione da Pz. 200 / Pack of 200 Pcs.		

Giunzione 30-1V / Connection 30-1V

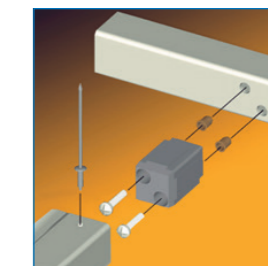
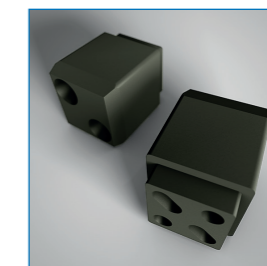
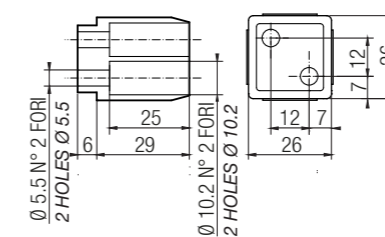

Caratteristiche tecniche / Technical features

Materiale / Material	Codice / Code	Peso (gr) / Weight (g)
Nylon RAL 7039 / Nylon RAL 7039	DGIPD0000052 / XF35101G	14,00
Confezione da Pz. 200 / Pack of 200 Pcs.		

Collarino per giunzione / Connection collar

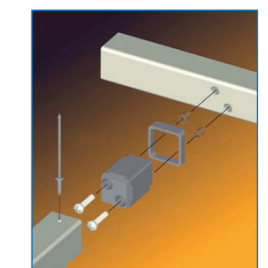
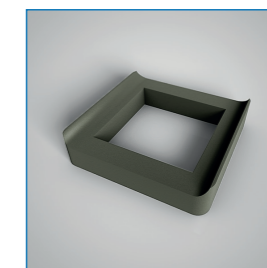
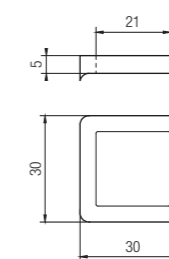

Caratteristiche tecniche / Technical features

Materiale / Material	Codice / Code	Peso (gr) / Weight (g)
Nylon RAL 7039 / Nylon RAL 7039	DBOXX0000042 / XF63001G	3,00
Confezione da Pz. 200 / Pack of 200 Pcs.		

Collarino giunzione 30 / Connection collar 30

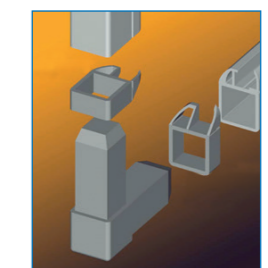
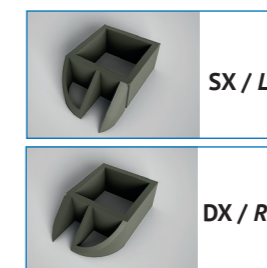
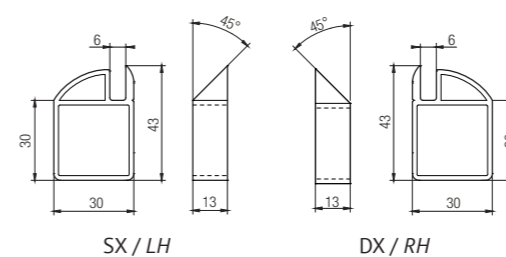

Caratteristiche tecniche / Technical features

Materiale / Material	Codice / Code	Peso (gr) / Weight (g)
Nylon RAL 7039 SX / Nylon RAL 7039 LH	DBOXX0000039 / XF63010G	3,00
Nylon RAL 7039 DX / Nylon RAL 7039 RH	DBOXX0000037 / XF63011G	3,00
Confezione da Pz. 200 / Pack of 200 Pcs.		



GUARNIZIONI E ACCESSORI *Gaskets and accessories*

Dierre Macap mette a disposizione una vasta gamma di accessori per completare e personalizzare le vostre strutture. Tutti gli accessori in catalogo garantiscono piena compatibilità di montaggio con i sistemi Serie 20-25 e 30 distinguendosi per la qualità dei materiali e la funzionalità.

Dierre Macap offers a wide range of accessories to complete and customize your structures. All the accessories in the catalogue guarantee full assembly compatibility with the 20-25 and 30 Series systems, distinguishing themselves through the quality of materials and functionality.

N.B. Tutte le immagini di questo catalogo sono rendering realizzati dai disegni 3D degli articoli raffigurati, pertanto il colore del materiale in queste immagini potrebbe non corrispondere esattamente alla tonalità reale degli articoli. Per qualsiasi informazione contattare info@dierre.eu

N.B.: All images in this catalogue are renderings made from 3D drawings of the items depicted, therefore the colour of the material in these images may not exactly match the actual shade of the items. For any information contact info@dierre.eu

Guarnizione tamponamento #5-6 / Buffer gasket #5-6

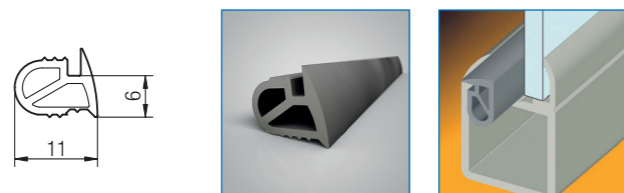

Caratteristiche tecniche / Technical features

Materiale / Material	Codice / Code	Peso (gr/mt) / Weight (g/m)
PVC RAL 7023 / PVC RAL 7023	DGUCA0000039 / XF20101G	63,00
Rotoli metri 150 / 150 metre rolls		

Guarnizione tamponamento #4 / Buffer gasket #4

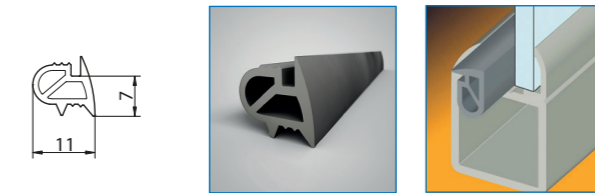

Caratteristiche tecniche / Technical features

Materiale / Material	Codice / Code	Peso (gr/mt) / Weight (g/m)
PVC RAL 7023 / PVC RAL 7023	DGUCA0000038 / XF20104G	63,00
Rotoli metri 125 / 125 metre rolls		

Guarnizione tamponamento lamiera / Sheet buffer gasket

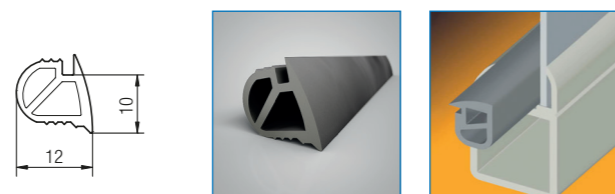

Caratteristiche tecniche / Technical features

Materiale / Material	Codice / Code	Peso (gr/mt) / Weight (g/m)
PVC RAL 7023 / PVC RAL 7023	DGUCA0000036 / XF20102G	79,00
Rotoli metri 100 / 100 metre rolls		

Guarnizione battuta sportello / Hatch stop gasket

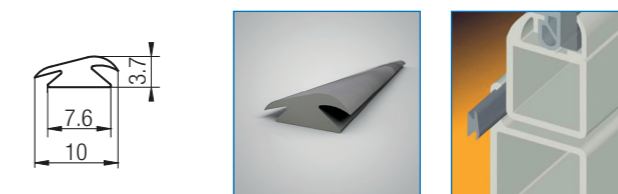

Caratteristiche tecniche / Technical features

Materiale / Material	Codice / Code	Peso (gr/mt) / Weight (g/m)
PVC RAL 7023 / PVC RAL 7023	DGUXX0000001 / XF20107G	28,00
Rotoli metri 250 / 250 metre rolls		

Guarnizione tamponamento #8 / Buffer gasket #8

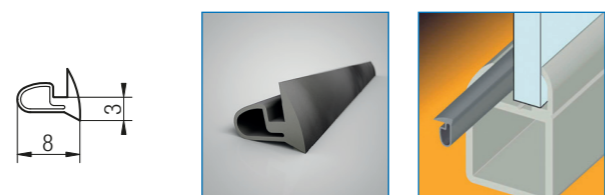

Caratteristiche tecniche / Technical features

Materiale / Material	Codice / Code	Peso (gr/mt) / Weight (g/m)
PVC RAL 7023 / PVC RAL 7023	DGUCA0000040 / XF20103G	20,00
Rotoli metri 200 / 200 metre rolls		

Guarnizione tamponamento per tubo 20 / Buffer gasket for 20 tube

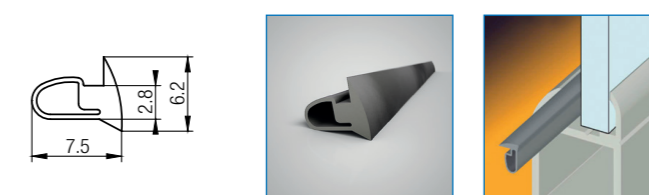

Caratteristiche tecniche / Technical features

Materiale / Material	Codice / Code	Peso (gr/mt) / Weight (g/m)
PVC RAL 7023 / PVC RAL 7023	DGUCA0000037 / XF20109G	20,00
Rotoli metri 200 / 200 metre rolls		

MANIGLIE / HANDLES

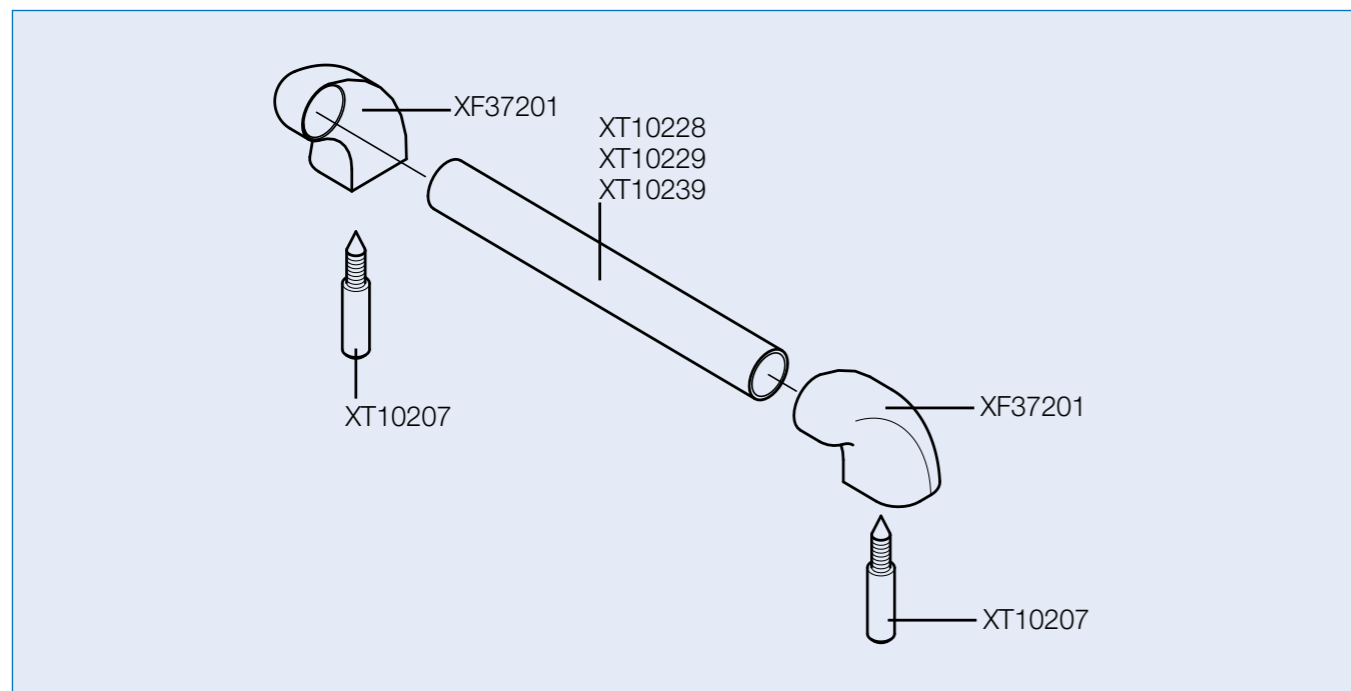

Testa maniglia / Handle head

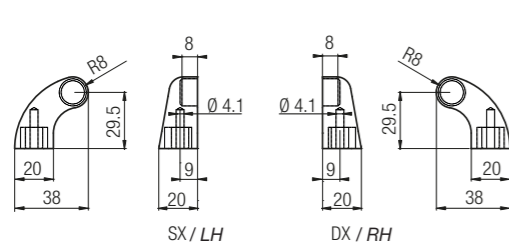

NB: La fornitura prevede un pezzo dx e uno sx
N.B.: The supply includes a RH and a LH piece



Caratteristiche tecniche / Technical features

Materiale / Material	Codice / Code	Peso (gr) / Weight (g)
Nylon RAL 2004 Arancio / Nylon RAL 2004 Orange	CMNSP0000002 / XF37201A	24,00
Nylon RAL 7039 Grigio / Nylon RAL 7039 Grey	CMNSP0000004 / XF37201G	24,00
Nylon RAL 1795 Rosso / Nylon RAL 1795 Red	CMNSP0000013 / XF37201R	24,00
Nylon RAL 6024 Verde / Nylon RAL 6024 Green	CMNSP0000014 / XF37201V	24,00
Nylon RAL 5010 Blu / Nylon RAL 5010 Blue	CMNSP0000003 / XF37201B	24,00
Nylon RAL 5010 Nero / Nylon RAL 5010 Black	CMNSP0000011 / XF37201N	24,00
Nylon RAL 5010 Rosso Speciale / Nylon RAL 5010 Special Red	CMNSP0000012 / XF37201F	24,00

Colore a scelta con un minimo di 1000 Pz. / Colour of your choice with a minimum of 1000 pcs.

Tubo maniglia int. 115 / Handle tube int. 115

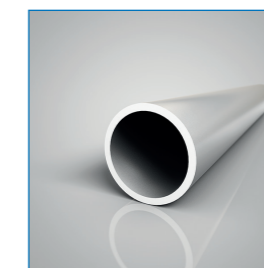
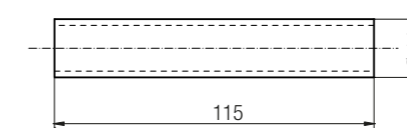

Caratteristiche tecniche / Technical features

Materiale / Material	Codice / Code	Peso (gr) / Weight (g)
Alluminio anodizzato ARGENTO / SILVER anodized aluminium	VP RTE0000003 / XT10228	18,00
Alluminio anodizzato ELOX / ELOX anodized aluminium	VP RTE0000004 / XT10229	18,00
Inox / Stainless steel	VP RAD0000005 / XT10239	33,00

Colore / lunghezza tubo maniglia a scelta con un minimo di 10 Pz. / Colour / length of handle tube of your choice with a minimum of 10 pcs.

Vite MTG maniglia salvadito soffiato / MTG Screw bellows finger guard handle

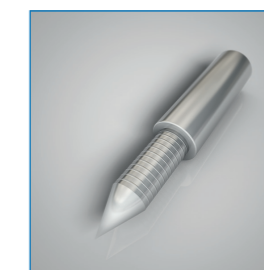
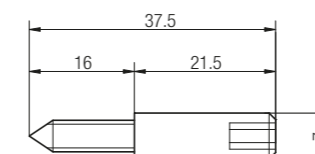

Caratteristiche tecniche / Technical features

Materiale / Material	Codice / Code	Peso (gr) / Weight (g)
Acciaio zincato / Galvanized steel	DVIXX0000004 / XT10207	8,00

Boccola con inserto M5 / Bushing with M5 insert

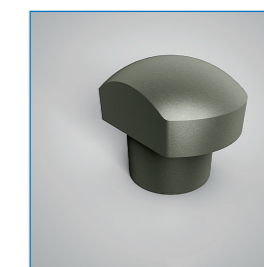
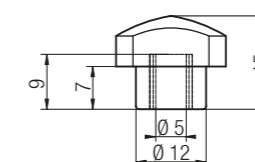

Caratteristiche tecniche / Technical features

Materiale / Material	Codice / Code	Peso (gr) / Weight (g)
Nylon RAL 7039 / Nylon RAL 7039	DBOXX0000005 / XT80110	4,00

MANIGLIE / HANDLES

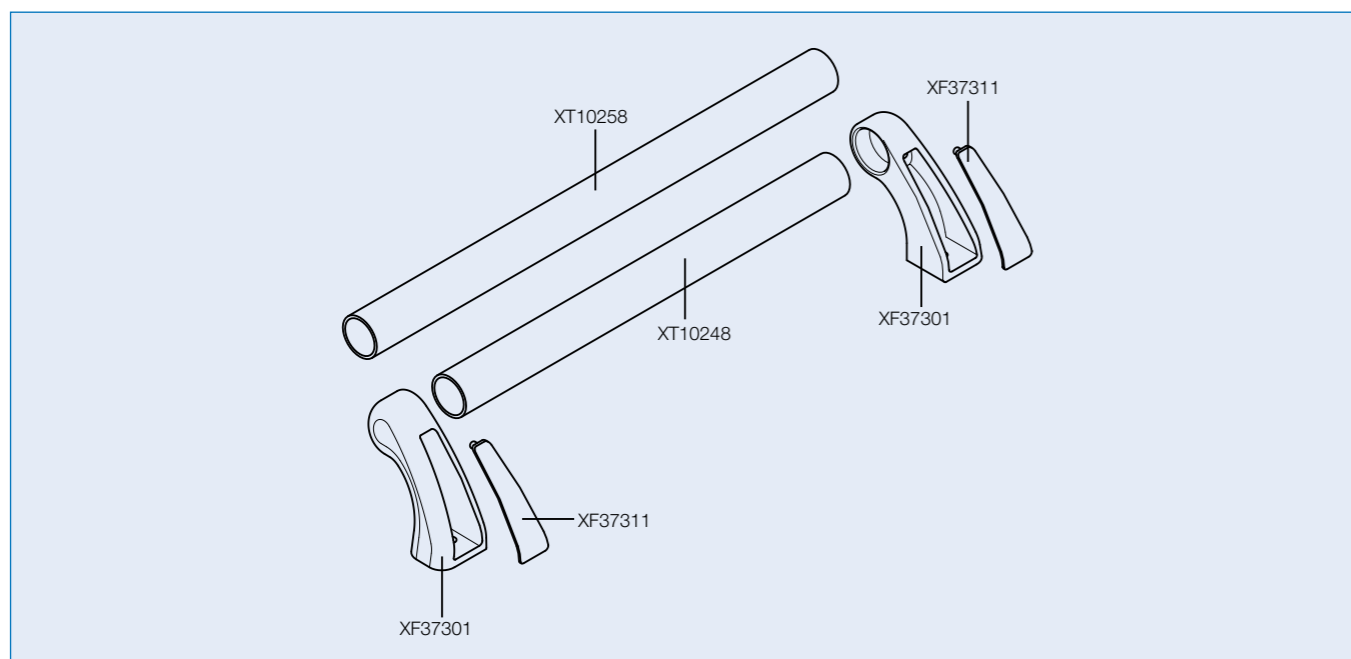

Testa maniglia DX/SX SERIE MAXI / MAXI SERIES RH/LH Handle head

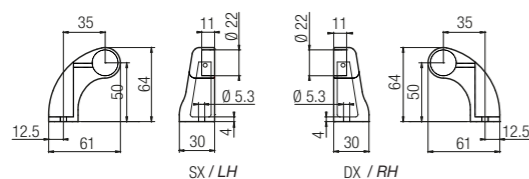

NB: La fornitura prevede un pezzo dx e uno sx
N.B.: The supply includes a RH and a LH piece



Caratteristiche tecniche / Technical features

Materiale / Material	Codice / Code	Peso (gr) / Weight (g)
Nylon RAL 2004 Arancio / Nylon RAL 2004 Orange	CMNSP0000005 / XF37301A	52,50
Nylon RAL 7039 Grigio / Nylon RAL 7039 Grey	CMNSP0000001 / XF37301G	52,50
Nylon RAL 1795 Rosso / Nylon RAL 1795 Red	CMNSP0000008 / XF37301R	52,50
Nylon RAL 6024 Verde / Nylon RAL 6024 Green	CMNSP0000010 / XF37301V	52,50
Nylon RAL 5010 Blu / Nylon RAL 5010 Blue	CMNSP0000006 / XF37301B	52,50
Nylon RAL 5010 Nero / Nylon RAL 5010 Black	CMNSP0000007 / XF37301N	52,50
Nylon RAL 5010 Rosso Speciale / Nylon RAL 5010 Special Red	CMNSP0000009 / XF37301F	52,50

Tappo Coprivite DX/SX per maniglia SERIE MAXI / RH / LH Screw cover cap for MAXI SERIES handle

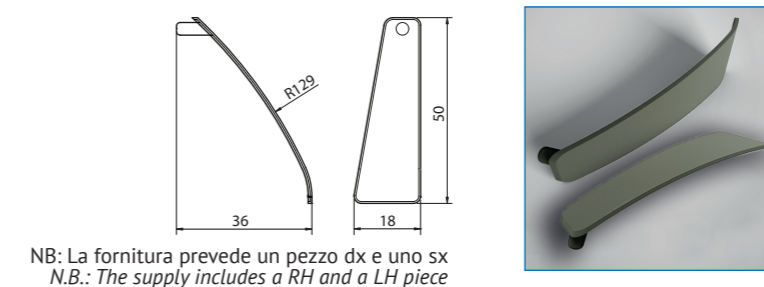

NB: La fornitura prevede un pezzo dx e uno sx
N.B.: The supply includes a RH and a LH piece

Caratteristiche tecniche / Technical features

Materiale / Material	Codice / Code	Peso (gr) / Weight (g)
Nylon RAL 2004 Arancio / Nylon RAL 2004 Orange	CTPYY0000004 / XF37311A	3,00
Nylon RAL 7039 Grigio / Nylon RAL 7039 Grey	CTPYY0000006 / XF37311G	3,00
Nylon RAL 1795 Rosso / Nylon RAL 1795 Red	CTPYY0000008 / XF37311R	3,00
Nylon RAL 6024 Verde / Nylon RAL 6024 Green	CTPYY0000003 / XF37311V	3,00
Nylon RAL 5010 Blu / Nylon RAL 5010 Blue	CTPYY0000005 / XF37311B	3,00
Nylon RAL 5010 Nero / Nylon RAL 5010 Black	CTPYY0000007 / XF37311N	3,00
Nylon RAL 5010 Rosso Speciale / Nylon RAL 5010 Special Red	CTPYY0000009 / XF37311F	3,00

Tubo maniglia int. 250 SERIE MAXI / Handle tube int. 250 MAXI SERIES

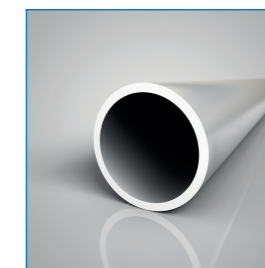
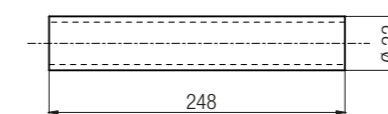

Caratteristiche tecniche / Technical features

Materiale / Material	Codice / Code	Peso (gr) / Weight (g)
Alluminio anodizzato ARGENTO / SILVER anodized aluminium	VP RTE0000002 / XT10248	65,00
Alluminio anodizzato ELOX / ELOX anodized aluminium	VP RTE0000005 / XT10249	65,00

Colore / lunghezza tubo maniglia a scelta con un minimo di 10 Pz. / Colour / length of handle tube of your choice with a minimum of 10 pcs.

Tubo maniglia int. 300 SERIE MAXI / Handle tube int. 300 MAXI SERIES

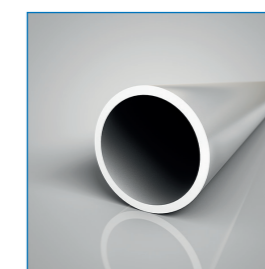

Caratteristiche tecniche / Technical features

Materiale / Material	Codice / Code	Peso (gr) / Weight (g)
Alluminio anodizzato ARGENTO / SILVER anodized aluminium	VP RTE0000006 / XT10258	79,00
Alluminio anodizzato ELOX / ELOX anodized aluminium	VP RTE0000007 / XT10259	79,00

Colore / lunghezza tubo maniglia a scelta con un minimo di 10 Pz. / Colour / length of handle tube of your choice with a minimum of 10 pcs.

Boccola Filettata M4- M5 -M6 Cieca / M4- M5 -M6 Blind Threaded Bush

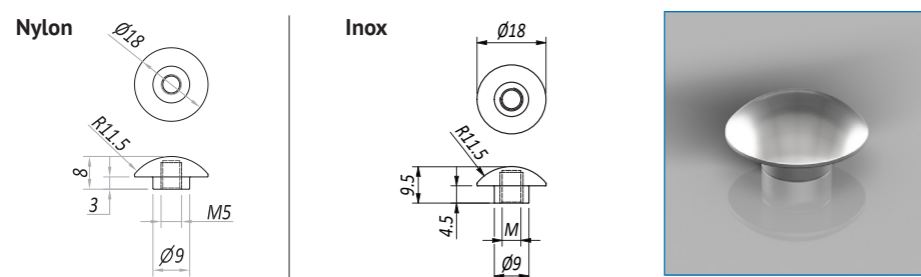

Caratteristiche tecniche / Technical features

Materiale / Material	M:	Codice / Code	Peso (gr) / Weight (g)
Inox/ Stainless steel	4	DTPXX0000018	8
Inox/ Stainless steel	5	DTPXX0000019	7
Inox/ Stainless steel	6	DTPXX0000020	7
Nylon blu RAL 5002 lucido/ Glossy blue RAL 5002 nylon	5	DTPXX0000068	1
Nylon giallo RAL 1023 lucido/ Glossy yellow RAL 1023 nylon	5	DTPXX0000070	1
Nylon grigio RAL 9006 lucido/ Glossy grey RAL 9006 nylon	5	DTPXX0000071	1

Boccola per vite M6 / Bushing for M6 screw



Caratteristiche tecniche / Technical features

Materiale / Material	Codice / Code	Peso (gr) / Weight (g)
Inox/ Stainless steel	DTPXX0000022 / XT90150	4

Gommino Distanziale / Rubber Spacer



Caratteristiche tecniche / Technical features

Materiale / Material	Codice / Code	Peso (gr) / Weight (g)
PTFE	DDIXX0000079 / XT90151	5

MANIGLIE / HANDLES



Maniglia per scorrevole a scatto / Snap slide handle

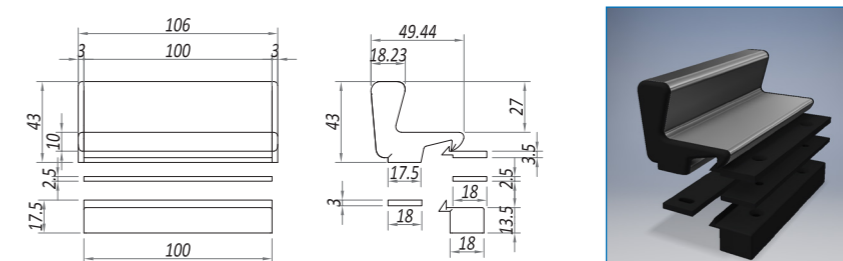

Caratteristiche tecniche / Technical features

Materiale / Material	Codice / Code	Peso (gr) / Weight (g)
Nylon RAL 7039 / Nylon RAL 7039	CMNYY0000016 / 15.325.00	500,00

Corpo maniglia aperta / Open handle body

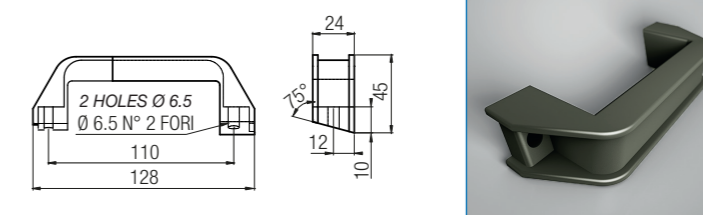

Caratteristiche tecniche / Technical features

Materiale / Material	Codice / Code	Peso (gr) / Weight (g)
Nylon RAL 7039 / Nylon RAL 7039	CMNYY0000009 / XF37101G	45,00

Corpo maniglia chiuso / Closed handle body

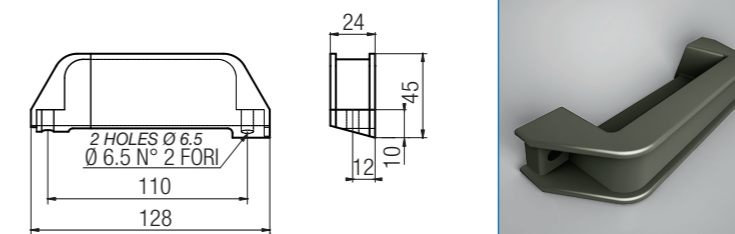

Caratteristiche tecniche / Technical features

Materiale / Material	Codice / Code	Peso (gr) / Weight (g)
Nylon RAL 7039 / Nylon RAL 7039	DMNTQ0000005 / XF37105G	54,00

Coprimaniglia / Handle cover

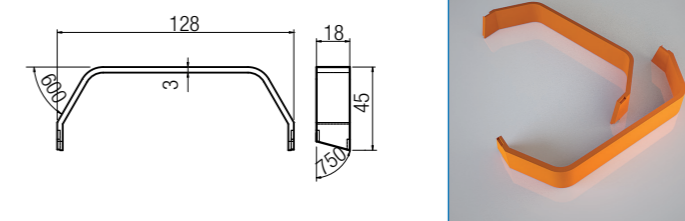

Caratteristiche tecniche / Technical features

Materiale / Material	Codice / Code	Peso (gr) / Weight (g)
Nylon RAL 2004 / Nylon RAL 2004	DMNTQ0000001 / XF37111	8,00

Supporto trascinamento scorrevole / Slide pulling support

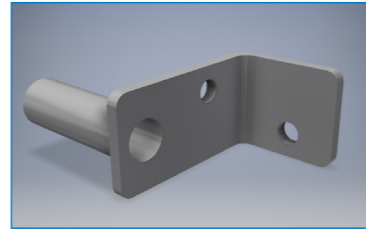
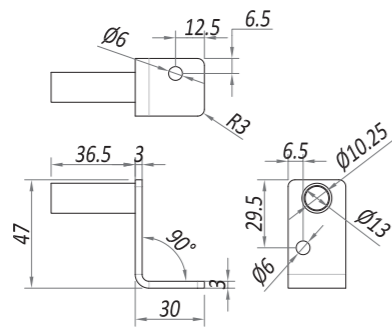

Caratteristiche tecniche / Technical features

Materiale / Material	Codice / Code	Peso (gr) / Weight (g)
Acciaio INOX / Stainless Steel	DSPXX0000134 / XT90051	50,00

Supporto spingitore scorr. Acciaio Inox / Stainless Steel sliding pusher support

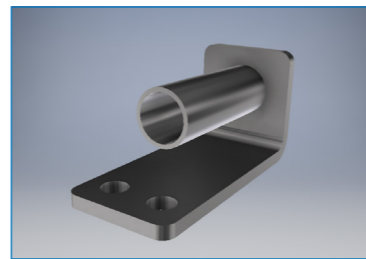
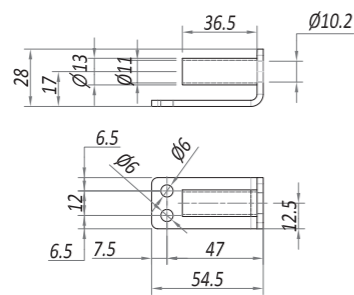

Caratteristiche tecniche / Technical features

Materiale / Material	Codice / Code	Peso (gr) / Weight (g)
Acciaio INOX / Stainless Steel	DSPXX0000131 / XT90165 (XT90052)	50,00

Pistoncino a gas smove salice D006SNG / Smove Salice D006SNG gas damper

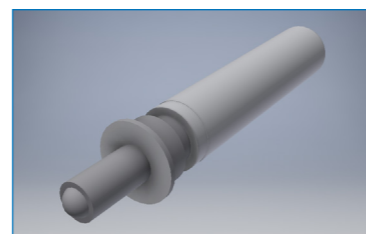
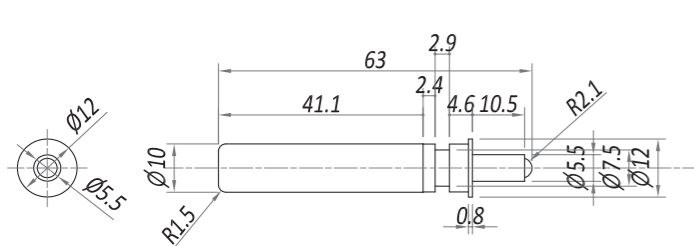

Caratteristiche tecniche / Technical features

Materiale / Material	Codice / Code	Peso (gr) / Weight (g)
Poliammide (chiavetta) / Polyamide (key)	CPMPI0000002 / XC29907	4,00

Montaggio per magnete RMC018 per sportello / Mounting for RMC018 magnet for hatch

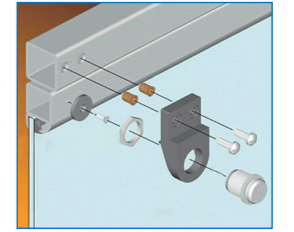
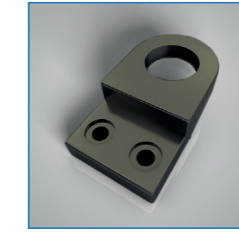
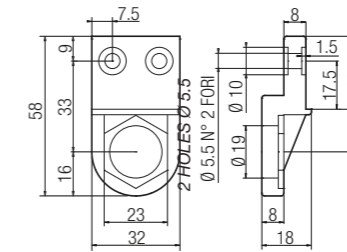

Caratteristiche tecniche / Technical features

Materiale / Material	Codice / Code	Peso (gr) / Weight (g)
Nylon RAL 7039 / Nylon RAL 7039	DSPXX0000019 / XF40201G	13,00

Montaggio per magnete RMC018 su base / Mounting for RMC018 magnet on base

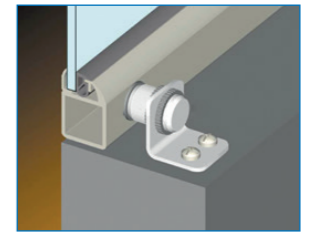
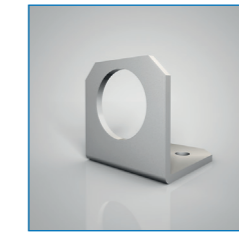
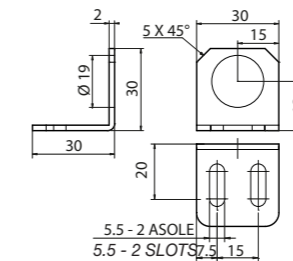

Caratteristiche tecniche / Technical features

Materiale / Material	Codice / Code	Peso (gr) / Weight (g)
Acciaio INOX / STAINLESS steel	DSPXX0000035 / XT90003	13,00

Magnete RMC018 / RMC018 Magnet

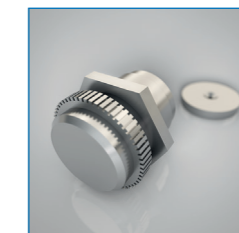
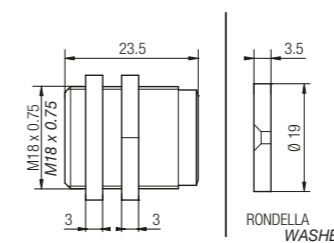

Caratteristiche tecniche / Technical features

Materiale / Material	Codice / Code	Peso (gr) / Weight (g)
Ottone nichelato / Nickel-plated brass	CMGPE0000014 / XC50111	49,00

Riscontro magnete RLC18 per sportello / RLC18 Magnet striker plate for hatch

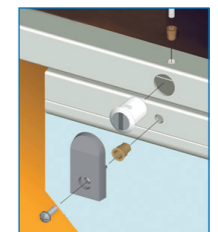
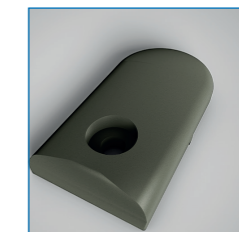
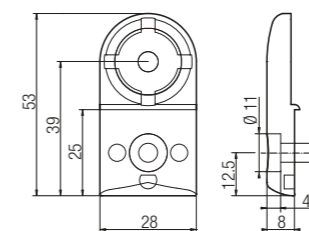

Caratteristiche tecniche / Technical features

Materiale / Material	Codice / Code	Peso (gr) / Weight (g)
Nylon RAL 7039 / Nylon RAL 7039	DSPXX0000021 / XF40202G	16,00

Riscontro magnete RLC18 per soffietto / RLC18 Magnet striker plate for bellows

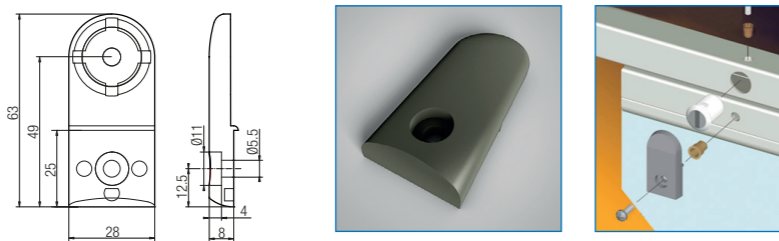

Caratteristiche tecniche / Technical features

Materiale / Material	Codice / Code	Peso (gr) / Weight (g)
Nylon RAL 7039 / Nylon RAL 7039	DSPXX0000020 / XF40203G	18,00

Magnete RLC18 / Magnet RLC18

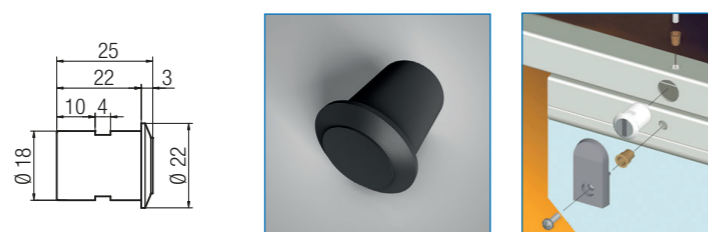

Caratteristiche tecniche / Technical features

Materiale / Material	Codice / Code	Peso (gr) / Weight (g)
Nylon nero / Black Nylon	CMGPE0000011 / XC50114	33,00

Staffa maschio chiusura scatto / Snap closure male bracket

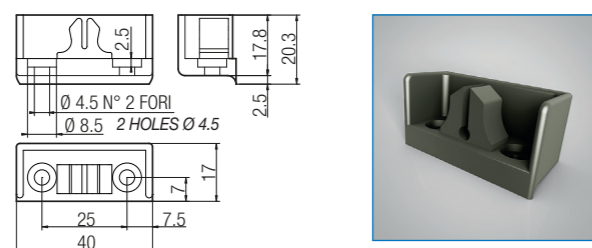

Caratteristiche tecniche / Technical features

Materiale / Material	Codice / Code	Peso (gr) / Weight (g)
Nylon RAL 7039 / Nylon RAL 7039	DSPXX0000006 / XF41002G	6,00

Riscontro femmina per soffietto / Female striker plate for bellows

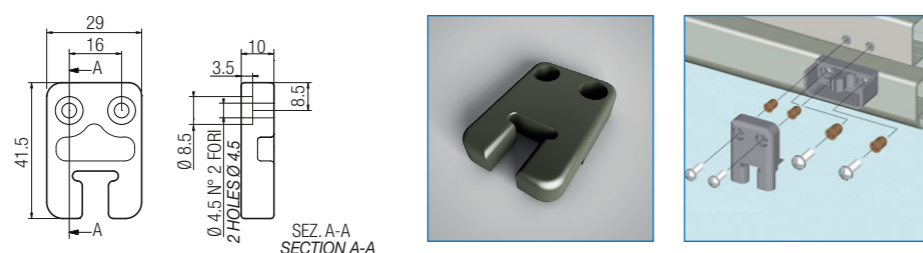

Caratteristiche tecniche / Technical features

Materiale / Material	Codice / Code	Peso (gr) / Weight (g)
Nylon RAL 7039 / Nylon RAL 7039	CSRSC0000006 / XF41001G	9,00

Riscontro femmina per sportello / Female striker plate for Hatch

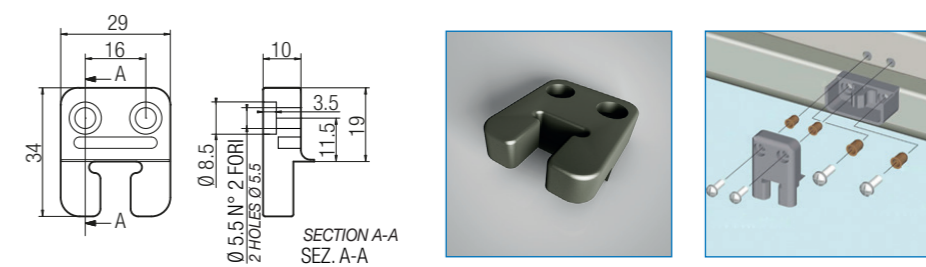

Caratteristiche tecniche / Technical features

Materiale / Material	Codice / Code	Peso (gr) / Weight (g)
Nylon RAL 7039 / Nylon RAL 7039	CSRSC0000007 / XF41003G	7,00

Serratura con chiave universale due alette / Lock with universal key with two wings

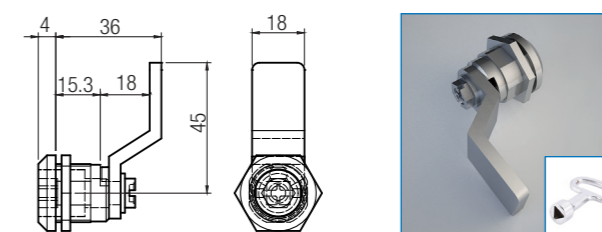

Caratteristiche tecniche / Technical features

Materiale / Material	Codice / Code	Peso (gr) / Weight (g)
Acciaio zincato / Galvanized steel	CSRSC0000009 / XC60132	42,00
Acciaio zincato / Galvanized steel	CSRAA0000003 / XC60199	19,00

Gruppo bloccaggio a pinza / Clamp locking unit



Caratteristiche tecniche / Technical features

Materiale / Material	Codice / Code	Peso (gr) / Weight (g)
Poliammide nero / Black polyamide	CSRSR0000006 / XC60211	29,00

Perno per gruppo bloccaggio a pinza / Pin for clamp locking unit

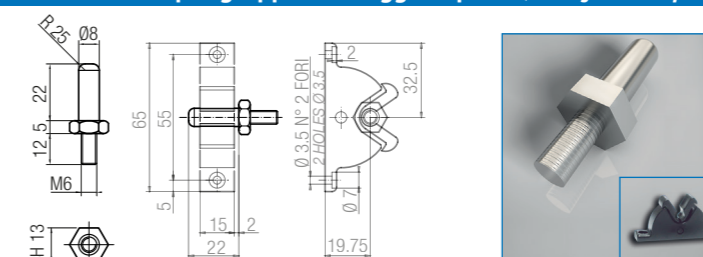

Caratteristiche tecniche / Technical features

Materiale / Material	Codice / Code	Peso (gr) / Weight (g)
Perno in Acciaio Zincato / Galvanized steel pin	DPEXX0000038 / XT10501	17,00
Perno in Acciaio Inox / Stainless steel pin	DPEXX0000037 / XT10501.1	16,00

Utilizzabile con bloccaggio cod. XC60211 / Can be used with locking cod. Nr. XC60211

Angolare L 30x30 fissaggio / Angular L 30x30 fixing

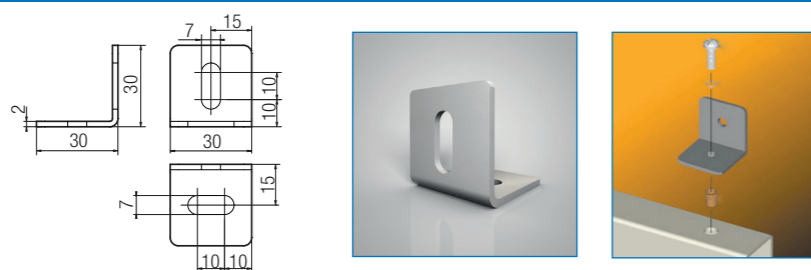

Caratteristiche tecniche / Technical features

Materiale / Material	Codice / Code	Peso (gr) / Weight (g)
Lamiera INOX / STAINLESS STEEL sheet	DSPXX0000105 / XT90048	37,00

Angolare L 50x30 fissaggio / Angular L 50x30 fixing

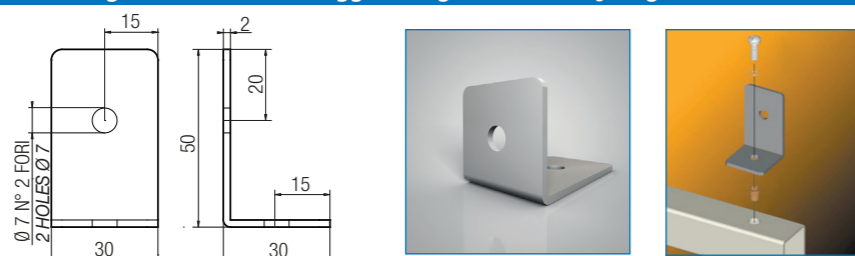

Caratteristiche tecniche / Technical features

Materiale / Material	Codice / Code	Peso (gr) / Weight (g)
Lamiera INOX / STAINLESS STEEL sheet	DSPXX0000104 / XT90030	50,00

Piastra 50x30 fissaggio / 50x30 Fixing plate



Caratteristiche tecniche / Technical features

Materiale / Material	Codice / Code	Peso (gr) / Weight (g)
Lamiera INOX / STAINLESS STEEL sheet	DSPXX0000100 / XT90027	22,00

Piastra 60x30 fissaggio / 60x30 Fixing plate



Caratteristiche tecniche / Technical features

Materiale / Material	Codice / Code	Peso (gr) / Weight (g)
Lamiera INOX / STAINLESS STEEL sheet	DSPXX0000101 / XT90017	26,00

Angolare di irrigidimento 90° / 90° Stiffening angle

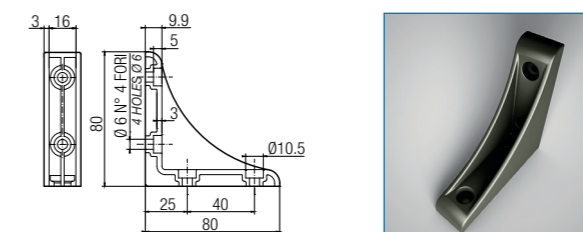

Caratteristiche tecniche / Technical features

Materiale / Material	Codice / Code	Peso (gr) / Weight (g)
Nylon RAL 7039 / Nylon RAL 7039	DGIPD0000063 / XT90039G	31,00

Angolare di irrigidimento 135° / 135° Stiffening angle

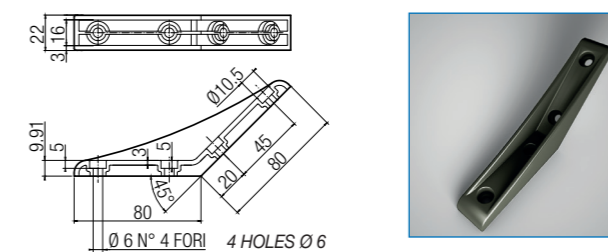

Caratteristiche tecniche / Technical features

Materiale / Material	Codice / Code	Peso (gr) / Weight (g)
Nylon RAL 7039 / Nylon RAL 7039	DGIPD0000060 / XT90038G	33,50

Pattino soffiato / Bellows runner

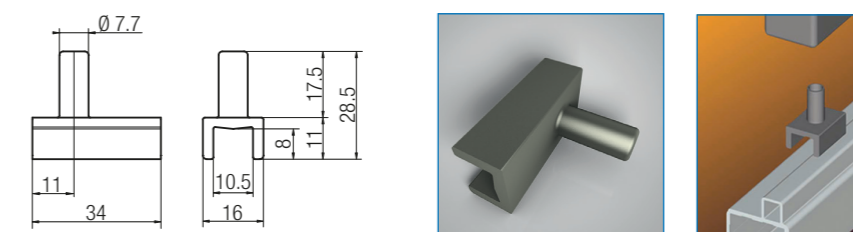

Caratteristiche tecniche / Technical features

Materiale / Material	Codice / Code	Peso (gr) / Weight (g)
Nylon grigio / Grey nylon	DPSST0000438 / XF36201G	4,50
Confezione quantità 50 Pz. / Pack of 50 Pcs.		

Pattino scorrevole / Sliding shoe

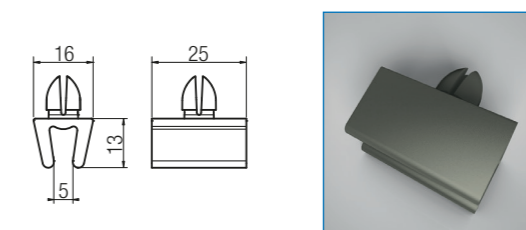

Caratteristiche tecniche / Technical features

Materiale / Material	Codice / Code	Peso (gr) / Weight (g)
Nylon grigio / Grey nylon	DPSST0000432 / XF36202G	0,50
Confezione quantità 50 Pz. / Pack of 50 Pcs.		

Vite h=23/M6 x 10 / Screw h=23/M6 x 10

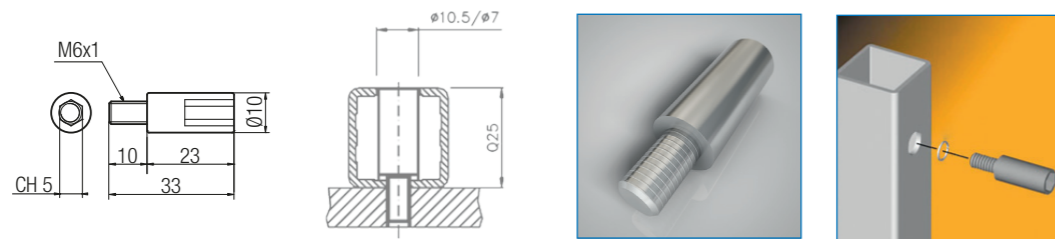

Caratteristiche tecniche / Technical features

Materiale / Material	Codice / Code	Peso (gr) / Weight (g)
Acciaio Zincato / Galvanized steel	DPEXX0000063 / XT10204	14,00

Vite h=28/M6 x 16 / Screw h=28/M6 x 16

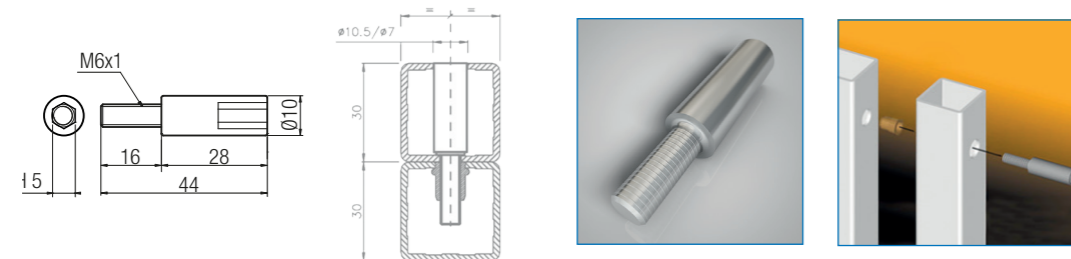

Caratteristiche tecniche / Technical features

Materiale / Material	Codice / Code	Peso (gr) / Weight (g)
Acciaio Zincato / Galvanized steel	DPEXX0000064 / XT10203	16,00

Vite h 58/M6 x 16 / Screw h 58/M6 x 16

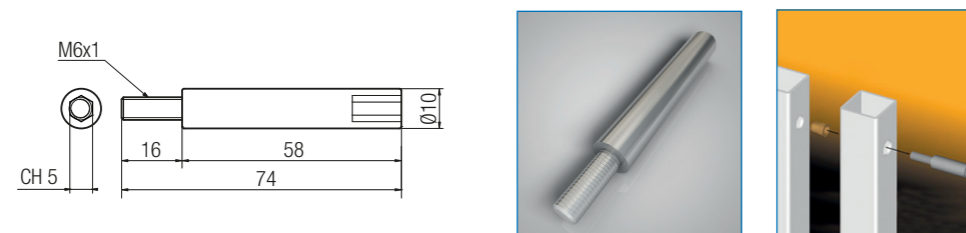

Caratteristiche tecniche / Technical features

Materiale / Material	Codice / Code	Peso (gr) / Weight (g)
Acciaio Zincato / Galvanized steel	DPEXX0000065 / XT10202	33,00

Supporto triangolare fiss. materiale plastico / Triangular support for fixing plastic material

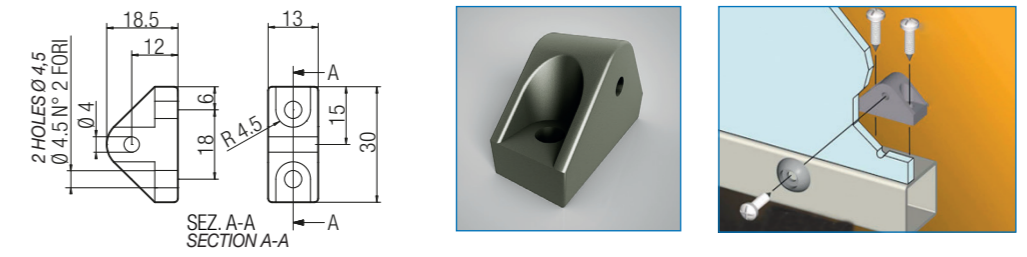

Caratteristiche tecniche / Technical features

Materiale / Material	Codice / Code	Peso (gr) / Weight (g)
Nylon RAL 7039 / Nylon RAL 7039	DSPXX0000138 / XF40101G	5,00

Angolare superiore / inferiore supporto rete / Upper / lower mesh corner support

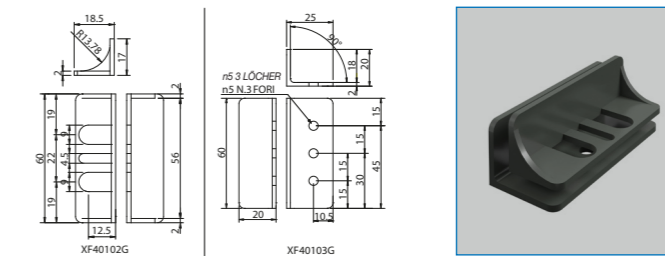

Caratteristiche tecniche / Technical features

Materiale / Material	Codice / Code	Peso (gr) / Weight (g)
Angolare Superiore - Nylon RAL 7039 / Upper Corner - Nylon RAL 7039	DANXX0000148 / XF40102G	4,50
Angolare Inferiore - Nylon RAL 7039 / Lower Corner - Nylon RAL 7039	DANXX0000129 / XF40103G	6,00

Supporto ferma vetro con rondella / Glass stop support with washer

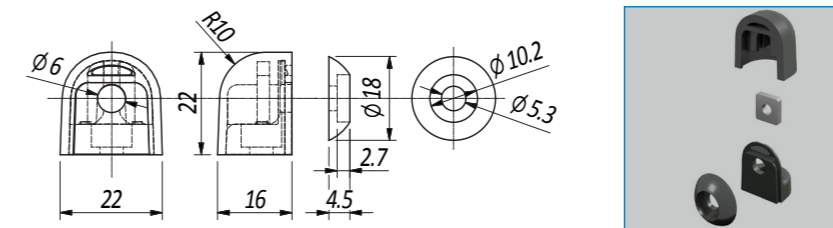

Caratteristiche tecniche / Technical features

Materiale / Material	Codice / Code	Peso (gr) / Weight (g)
Supprto fermavetro Nylon RAL 7039 / Glass stop support Nylon RAL 7039	DSPXX0000227 / XF40152G	5,00
Cursore 10x10 Acciaio Zincato / 10x10 Galvanized Steel Cursor	DDDCU0000025 / 26.013.00	1,50

Supporto raggiato fiss. materiale plastico / Radial support for fixing plastic material

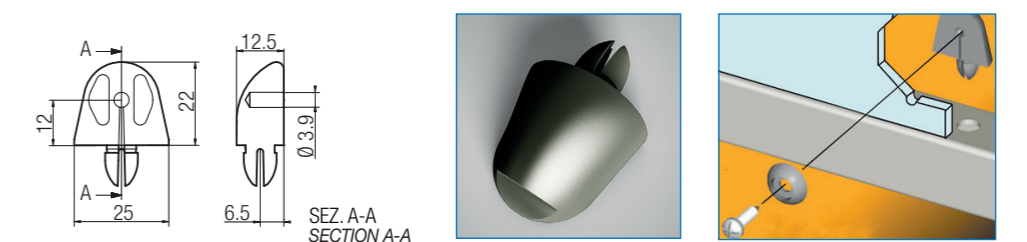

Caratteristiche tecniche / Technical features

Materiale / Material	Codice / Code	Peso (gr) / Weight (g)
Nylon RAL 7039 / Nylon RAL 7039	DSPXX0000110 / XF40151G	14,00

Conchiglia femmina fiss. materiale plastico e rete / Female shell for fixing plastic material and mesh

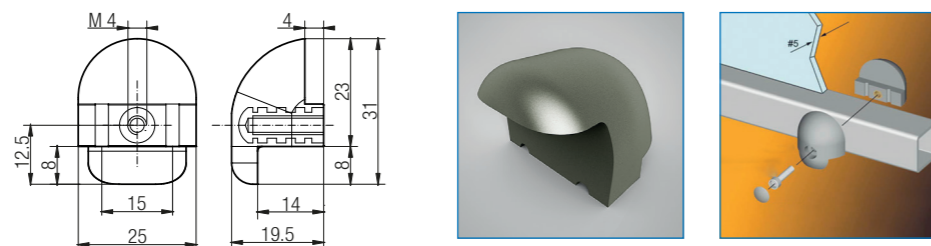

Caratteristiche tecniche / Technical features

Materiale / Material	Codice / Code	Peso (gr) / Weight (g)
Nylon RAL 7039 / Nylon RAL 7039	DMSXX0000053 / XF43001G	8,50

Conchiglia maschio per materiale plastico #3 e rete Ø 3 / Male shell for plastic material # 3 and mesh Ø 3

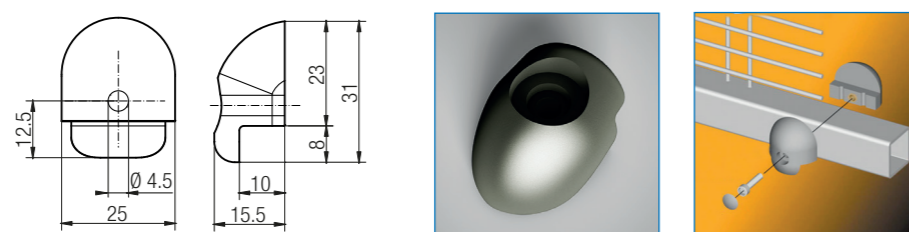

Caratteristiche tecniche / Technical features

Materiale / Material	Codice / Code	Peso (gr) / Weight (g)
Nylon RAL 7039 / Nylon RAL 7039	DMSXX0000062 / XF43002G	5,50

Conchiglia per materiale plastico #8 / Shell for plastic material # 8



Caratteristiche tecniche / Technical features

Materiale / Material	Codice / Code	Peso (gr) / Weight (g)
Nylon RAL 7039 / Nylon RAL 7039	DMSXX0000060 / XF43003G	4,50

Morsetto di sostegno VTM #5, #8, #10 / VTM Support clamp #5, #8, #10

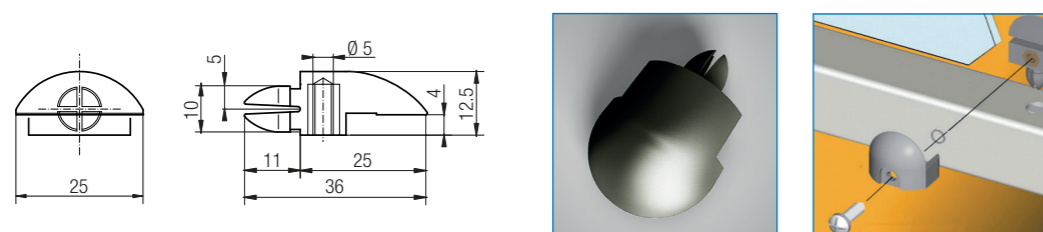

Caratteristiche tecniche / Technical features

Materiale / Material	Codice / Code	Peso (gr) / Weight (g)
Nylon RAL 7039 / Nylon RAL 7039	DMSXX0000074 / XF42001G	7,00

Morsetto di riscontro VTM #5, #8, #10 / VTM Striker clamp #5, #8, #10

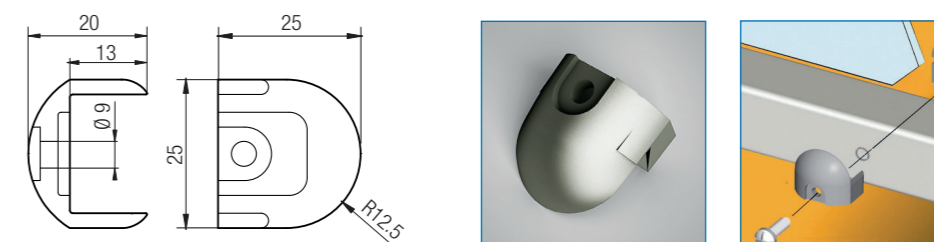

Caratteristiche tecniche / Technical features

Materiale / Material	Codice / Code	Peso (gr) / Weight (g)
Nylon RAL 7039 / Nylon RAL 7039	DMSXX0000071 / XF42002G	3,00

Rondella sottovite per VTC croce M5 / Under screw washer for VTC M5 cross-head screw

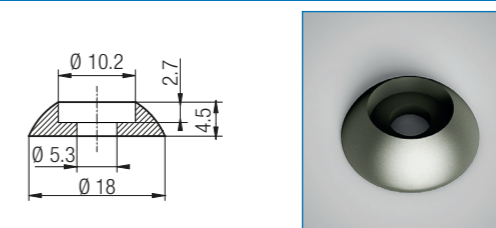

Caratteristiche tecniche / Technical features

Materiale / Material	Codice / Code	Peso (gr) / Weight (g)
Nylon RAL 7039 / Nylon RAL 7039	DROXX0000012 / XF52605G	0,50

Rondella sottovite per VTC croce M6 / Under screw washer for VTC M6 cross-head screw

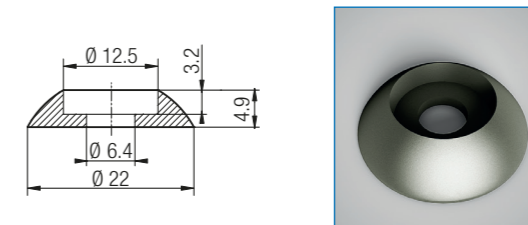

Caratteristiche tecniche / Technical features

Materiale / Material	Codice / Code	Peso (gr) / Weight (g)
Nylon RAL 7039 / Nylon RAL 7039	DROXX0000014 / XF52606G	0,50

Molle a gas senza blocco / Gas springs without lock

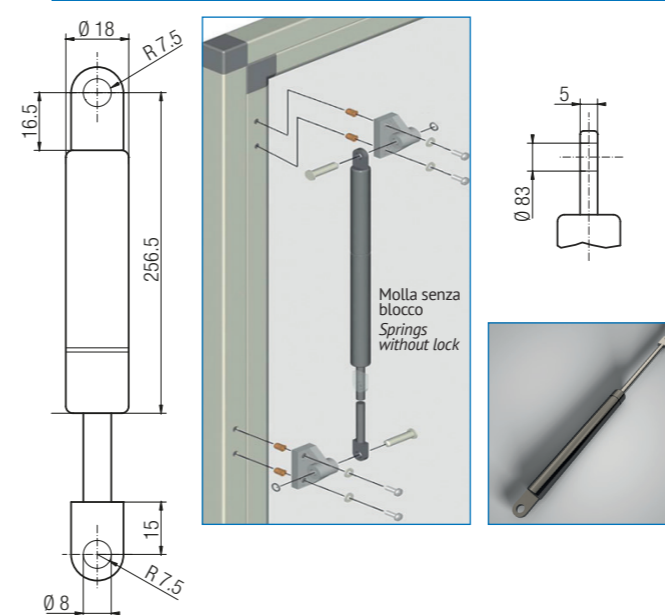

Corsa 120 / Stroke 120

Forza di estensione Extension force	Codice Code	Peso (gr) Weight (g)
15 KG / 150 N / 15 KG / 150 N	CMLGS0000069 / XC25415	168,00
25 KG / 250 N / 25 KG / 250 N	CMLGS0000074 / XC25425	168,00
35 KG / 350 N / 35 KG / 350 N	CMLGS0000082 / XC25435	189,00
40 KG / 400 N / 40 KG / 400 N	CMLGS0000085 / XC25440	170,00
50 KG / 500 N / 50 KG / 500 N	CMLGS0000088 / XC25450	170,00

Corsa 200 / Stroke 200

Forza di estensione Extension force	Codice Code	Peso (gr) Weight (g)
15 KG / 150 N / 15 KG / 150 N	CMLGS0000070 / XC25215	236,00
20 KG / 200 N / 20 KG / 200 N	CMLGS0000073 / XC25220	236,00
30 KG / 300 N / 30 KG / 300 N	CMLGS0000078 / XC25230	236,00
40 KG / 400 N / 40 KG / 400 N	CMLGS0000086 / XC25240	238,00
50 KG / 500 N / 50 KG / 500 N	CMLGS0000090 / XC25250	239,00

Maniglia Cremonese verniciata ral 9006 /

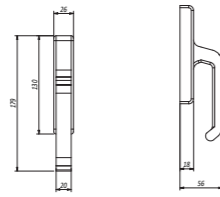

Caratteristiche tecniche / Technical features

Materiale / Material	Codice / Code	Peso (gr) / Weight (g)
Alluminio /	CSRSC0000003 / XC60501G	270,00

Blocchetto Per Aste Cremonese /

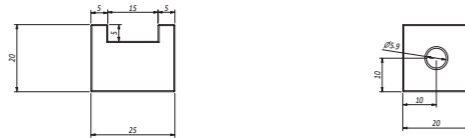

Caratteristiche tecniche / Technical features

Materiale / Material	Codice / Code	Peso (gr) / Weight (g)
Alluminio-elox /	DBLXX0000034 / XT90041	20,00

Asta Cremonese /

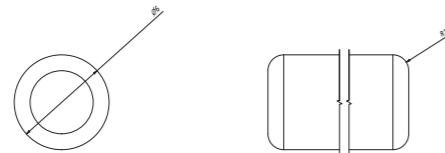

Caratteristiche tecniche / Technical features

Materiale / Material	Codice / Code	Peso (gr) / Weight (g)
Alluminio6060Anticorodal /	APRTT0000001 / XB10506	N/A

Boccola Per Aste Cremonesi /

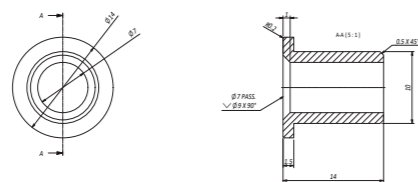

Caratteristiche tecniche / Technical features

Materiale / Material	Codice / Code	Peso (gr) / Weight (g)
Nylon /	DBOXX0000023 / XC30233	0,00

Cerniera soffietto con foro svasato / Bellows hinge with countersunk hole

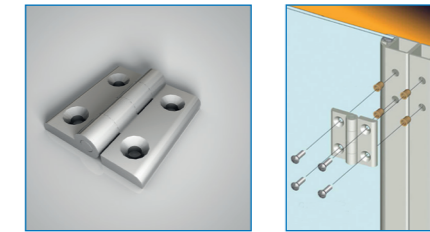
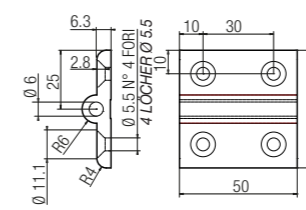

Caratteristiche tecniche / Technical features

Materiale / Material	Codice / Code	Peso (gr) / Weight (g)
Alluminio anodizzato ELOX / ELOX anodized aluminium	CCRY0000036 / XC40501E	50,00
Alluminio anodizzato ARGENTO / SILVER anodized aluminium	CCRY0000025 / XC40501	50,00

con perno / with pin

Tappo per foro 11 / Cap for 11 hole

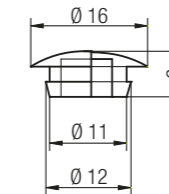

Caratteristiche tecniche / Technical features

Materiale / Material	Codice / Code	Peso (gr) / Weight (g)
Nylon Grigio / Grey nylon	CTPTU0000001 / XC30151	0,50

Confezione quantità 100 Pz. / Pack of 100 Pcs.

Tappo per foro 13 / Cap for 13 hole

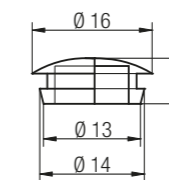

Caratteristiche tecniche / Technical features

Materiale / Material	Codice / Code	Peso (gr) / Weight (g)
Nylon Grigio / Grey nylon	CTPTU0000003 / XC30152	0,50

Confezione quantità 500 Pz. / Pack of 500 Pcs.

Fermo per portellone / Stop for port

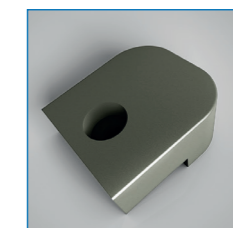
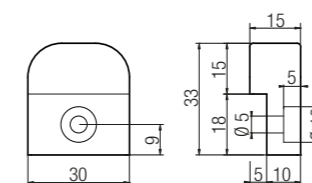

Caratteristiche tecniche / Technical features

Materiale / Material	Codice / Code	Peso (gr) / Weight (g)
Nylon RAL 7039 / Nylon RAL 7039	DSPXX0000016 / XF36401G	2,00

Confezione quantità 100 Pz. / Pack of 100 Pcs.

Canalina con coperchio 25x30 / 25x30 Duct with cover

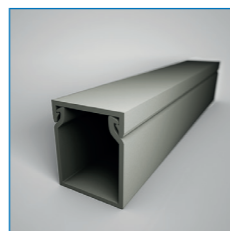
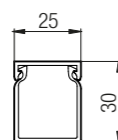

Caratteristiche tecniche / Technical features

Materiale / Material	Codice / Code	Peso (gr) / Weight (g)
PVC RAL 7030 / PVC RAL 7030	CMEPE0000001 / XE70125G	255,00
Lunghezza 2000 mm / Length 2000 mm		

Tappo per canalina 25x30 / Cap for 25x30 duct

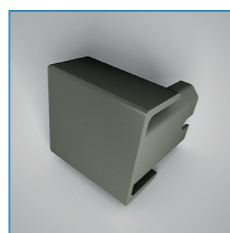
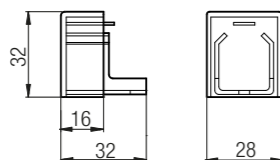

Caratteristiche tecniche / Technical features

Materiale / Material	Codice / Code	Peso (gr) / Weight (g)
PVC RAL 7030 / PVC RAL 7030	CMEAA0000012 / XE70225G	4,00
Confezione quantità 100 Pz. / Pack of 100 Pcs.		

Curva piana canalina / Flat duct curve

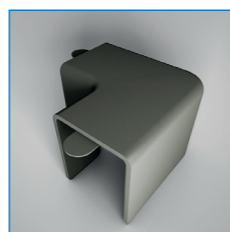
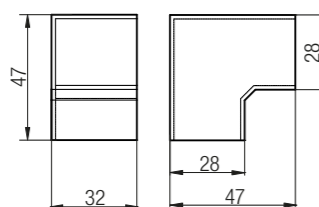

Caratteristiche tecniche / Technical features

Materiale / Material	Codice / Code	Peso (gr) / Weight (g)
PVC RAL 7030 / PVC RAL 7030	CMEAA0000002 / XE70425G	11,00
Confezione quantità 50 Pz. / Pack of 50 Pcs.		

Coperchio profilo portacavi 30x30 / 30x30 Cable holder profile cover

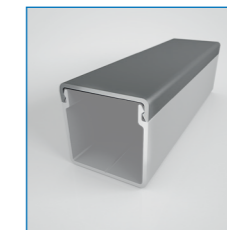
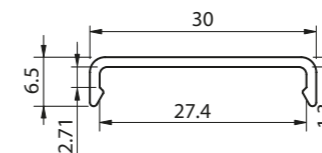

Caratteristiche tecniche / Technical features

Materiale / Material	Codice / Code	Peso (kg/mt) / Weight (kg/m)
Alluminio anodizzato ELOX / ELOX anodized aluminium	BPRCA0000005 / 01.CO3030.E	0,134
Alluminio anodizzato ARGENTO / SILVER anodized aluminium	BPRCA0000004 / 01.CO3030.A	0,134

Tubolare 25x25 Aisi 304 / 25x25 AISI 304 Tube

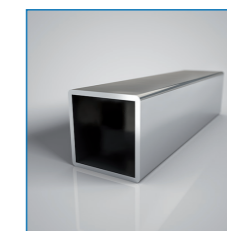
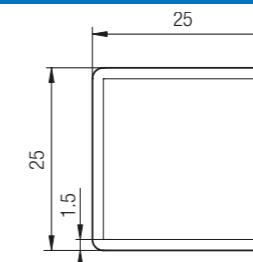

Caratteristiche tecniche / Technical features

Materiale / Material	Codice / Code	Peso (kg/mt) / Weight (kg/m)
Inox satinato / Satin stainless steel	ATUQC0000002 / XB40924S	1,450
Lunghezza barra 6000 mm / Bar length 6000 mm		

Pressacavo Ø26 / Cable clamp Ø26

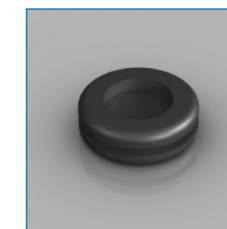
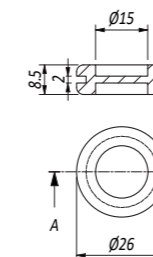

Caratteristiche tecniche / Technical features

Materiale / Material	Codice / Code	Peso (gr) / Weight (g)
Gomma / Rubber	CMEGC0000017	1

Cuffia protezione staffa micro / Microswitch bracket protection cap

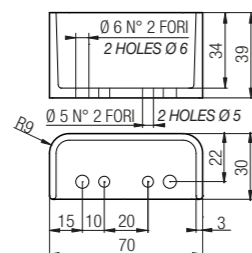

Caratteristiche tecniche / Technical features

Materiale / Material	Codice / Code	Peso (gr) / Weight (g)
Nylon nero / Black nylon	CTPYY0000010 / XF39101N	11,00
Nylon verde / Green nylon	CTPYY0000011 / XF39101V	
Confezione quantità 100 Pz. / Pack of 100 Pcs.		
NB: Colore a richiesta minimo 1000 Pz. / N.B.: Colour on request at least 1000 pcs.		

Canala profilo portacavi 30x30 / 30x30 Cable holder profile

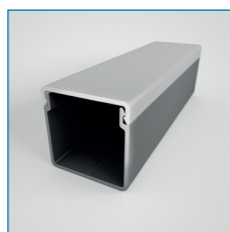
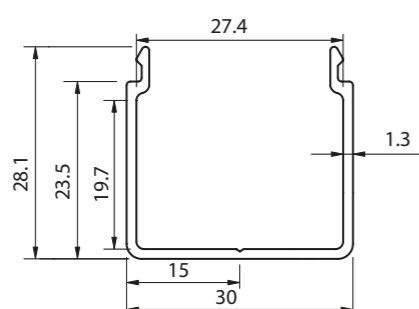

Caratteristiche tecniche / Technical features

Materiale / Material	Codice / Code	Peso (kg/mt) / Weight (kg/m)
Alluminio anodizzato ELOX / ELOX anodized aluminium	BPRCA0000002 / 01.CA3030.E	0,283
Alluminio anodizzato ARGENTO / SILVER anodized aluminium	BPRCA0000001 / 01.CA3030.A	0,283

Cornice Q.25 tamponato / Q.25 Buffer frame

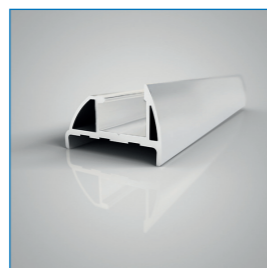
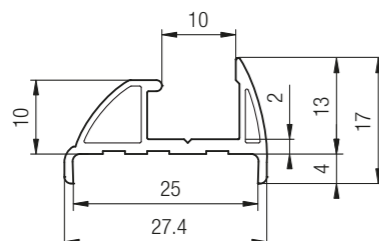

Caratteristiche tecniche / Technical features

Materiale / Material	Codice / Code	Peso (kg/mt) / Weight (kg/m)
PVC / PVC	BPRDD0000228 / XB42025X	0,142
Lunghezza barra 4500 mm / Bar length 4500 mm		
Utilizzabile anche per SERIE INOX / Can also be used for STAINLESS STEEL SERIES		

Giunzione 25/3VA per tubo inox sp. 1,5 mm / 25/3VA Connection for stainless steel pipe thk.1.5 mm

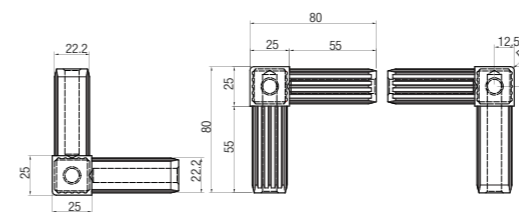

Caratteristiche tecniche / Technical features

Materiale / Material	Codice / Code	Peso (gr) / Weight (g)
Nylon + Inox / Nylon + Stainless steel	DGIPD0000049 / XF32506X	209,00
Confezione quantità 100 Pz. / Pack of 100 Pcs.		

Collarino per giunzione 25 / Collar for 25 connection

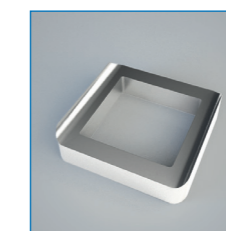
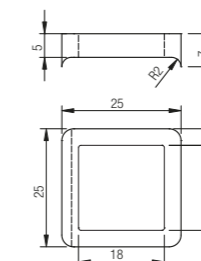

Caratteristiche tecniche / Technical features

Materiale / Material	Codice / Code	Peso (gr) / Weight (g)
Nylon / Nylon	DBOXX0000040 / XF62501X	2,00
Confezione quantità 200 Pz. / Pack of 200 Pcs.		

Giunzione 25/2VA per tubo inox sp. 1,5 mm / Connection 25/2VA for stainless steel pipe thk.1,5 mm

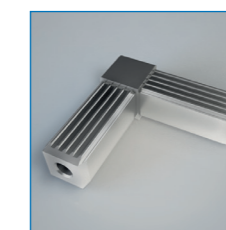
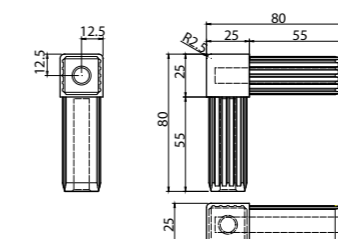

Caratteristiche tecniche / Technical features

Materiale / Material	Codice / Code	Peso (gr) / Weight (g)
Nylon + Inox / Nylon + Stainless steel	DGIPD0000042 / XF32505X	140,00
Confezione quantità 200 Pz. / Pack of 200 Pcs.		

DIERRE S.p.A.
HEADQUARTERS
Circ. S.Giovanni Ev., 23
41042 Spezzano di Fiorano (MO)
Tel. +39 0536.92.29.11
info@dierre.eu

STABILIMENTO MACAP
Sede Operativa Dierre S.p.A.
via del Selciatore, 12
40127 Bologna
Tel. +39 051.60.36.811
info@dierre.eu

STABILIMENTO MOTION
Sede Operativa Dierre S.p.A.
via Industria, 8-10
40050 Argelato (BO)
Tel. +39 051.66.34.711
info@dierremotion.com

DIERRE TOOLS
via Fedele Sutter, 29
44124 Ferrara
Tel. +39 051.66.34.711
info@dierremotion.com

STABILIMENTO ARIMETAL
Sede Operativa Dierre S.p.A.
via G. Marconi, 8
23843 Dolzago (LC)
Tel. +39 0341.45.34.11
arimetal@arimetal.it

DIERRE LOGISTICS
via Federico Boccalari, 16-18
46100 Mantova
tel +39 0536 922911
info@dierre.eu

DIERRE TOSCANA s.r.l.
via Siena, 11
59013 Oste-Montemurlo (PO)
Tel. +39 0574.72.20.61
info@dierretoscana.com

DIERRE DECATECH s.r.l.
via Marconi, 2/B
35010 Borgoricco (PD)
Tel. +39 049.93.36.019
info@dierredcatech.com

STABILIMENTO SCHIO
Sede Operativa Dierre Decatech s.r.l.
via Umbria, 9
36015 Schio (VI)
tel. +39 0445.57.53.57
commerciale.vi@dierredcatech.com

DIERRE SAFE s.r.l.
via Tolomeo, 10
36034 Malo (VI)
tel. +39 0445.16.00.220
info@dierresafe.eu

SINTESI s.r.l.
via Irpinia, 64
35020 Saonara (PD)
Tel. + 39 049.879.06.66
sintesi@sintesi.eu

IN.ECOSISTEMI s.r.l.
via Artigianato, 13
35020 Codevigo (PD)
Tel. + 39 049.581.78.11
info@inecosistemi.it



www.dierre.eu